

# INSTALLATION MANUAL

MONTAGEANLEITUNG  
INSTRUCTIONS DE MONTAGE  
ISTRUZIONI PER IL MONTAGGIO

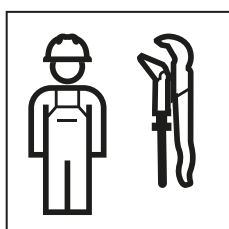

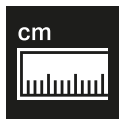

388.031.00.1

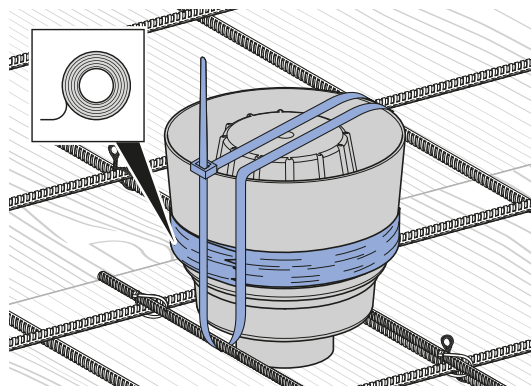
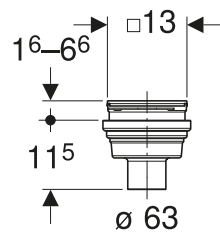

388.033.00.1

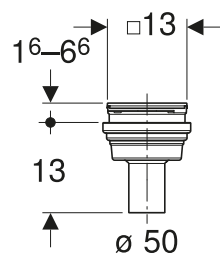

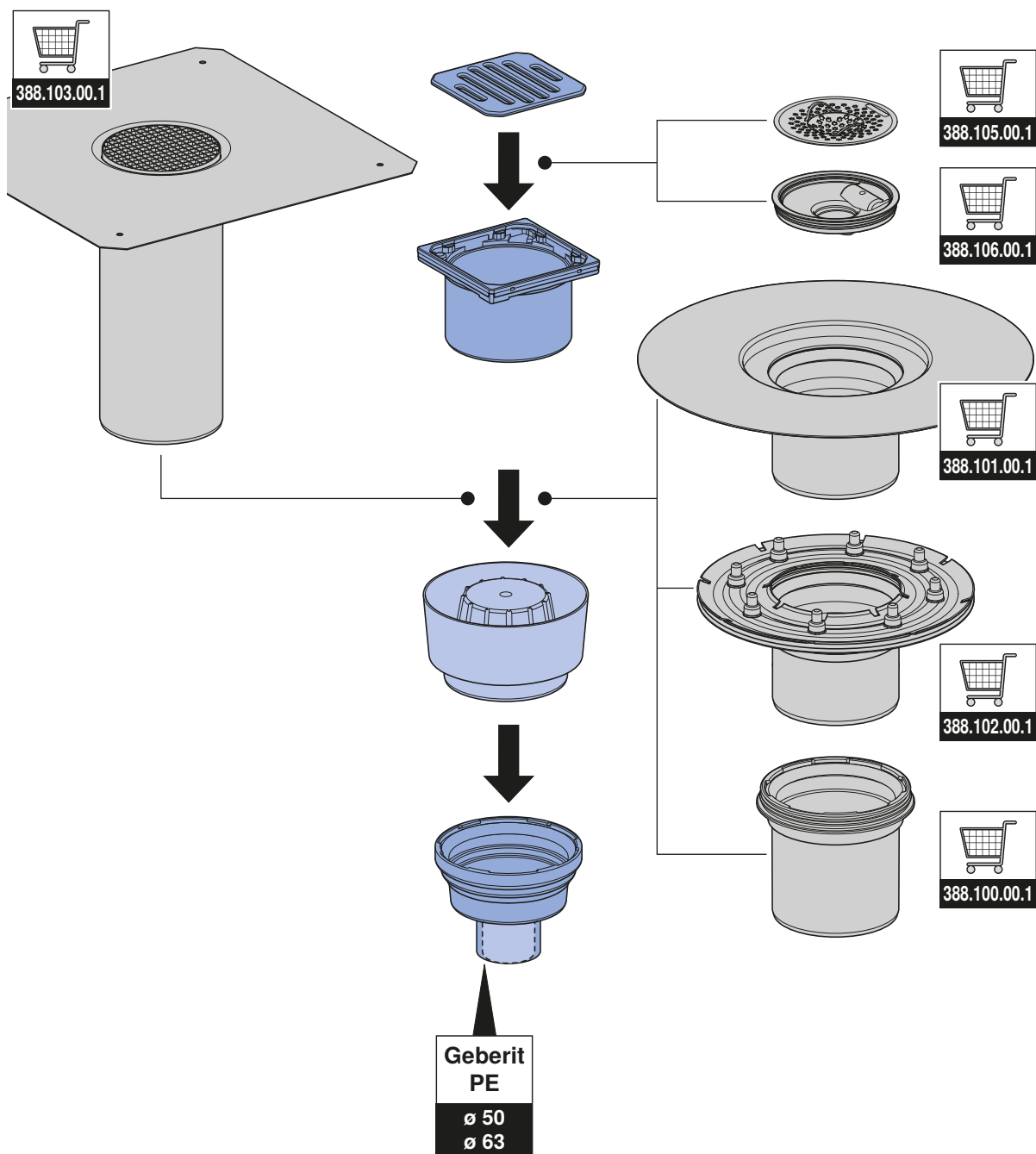

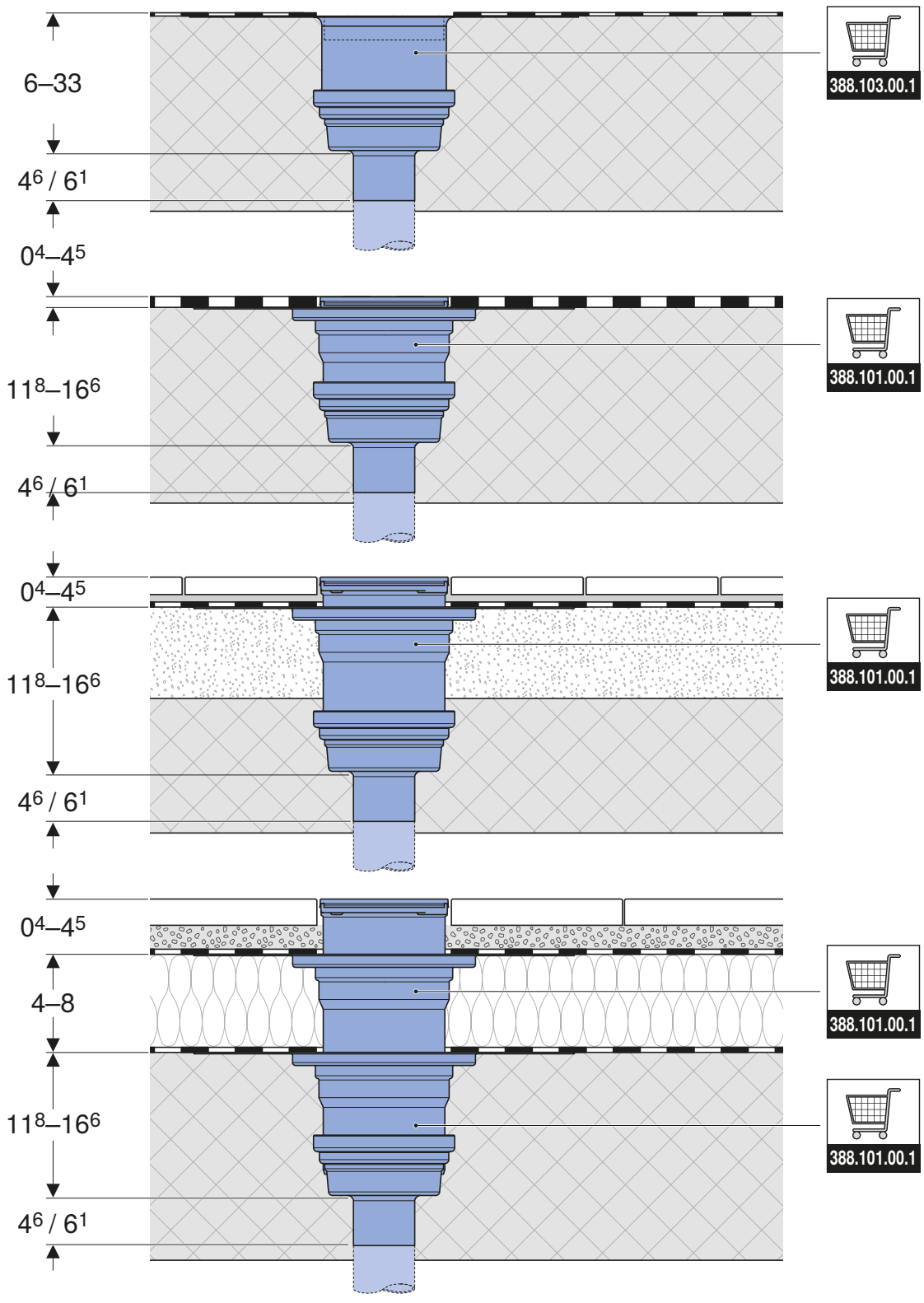

Geberit International AG  
 Schachenstrasse 77, CH-8645 Jona  
 documentation@geberit.com  
 www.geberit.com

