

HL62.1H/7 9,90 l/s DN75

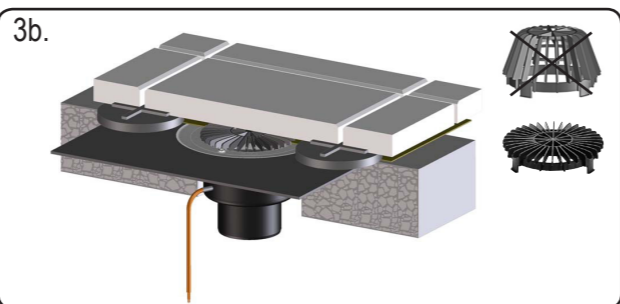
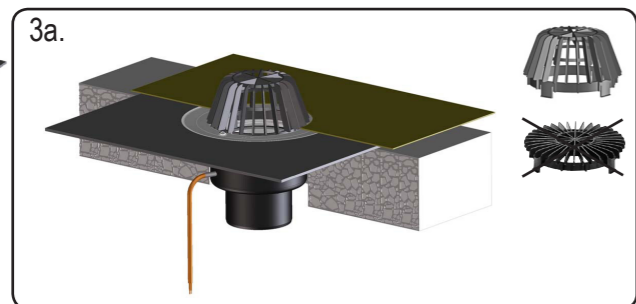
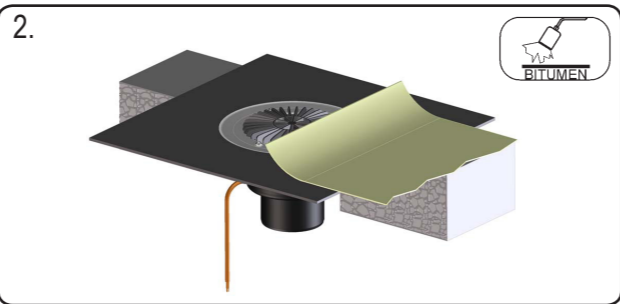
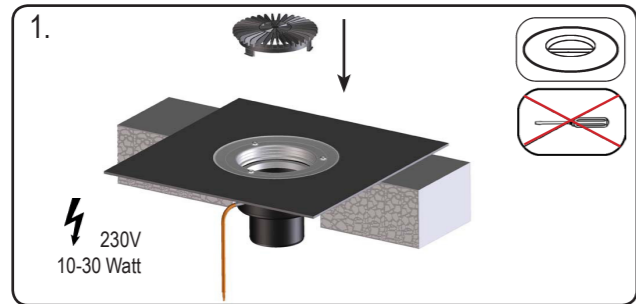
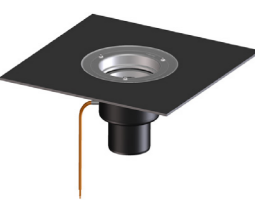

D Flachdach-Ablauf
I Scarico per tetti piani
GB Flat-roof drain
TR Düz çatı süzgeci
CZ/SK Střešní vtok
EX-YU slivnik za ravni krov
H Lapostető lefolyó
PL Wpust dachu płaskiego
SLO Odtok ravne strehe
RO Scurgere de pe terase
PYC Воронка для плоской кровли
BUL воронка за плосък покрив

14.08.2017

HL62.1H/7 9,90 l/s DN75

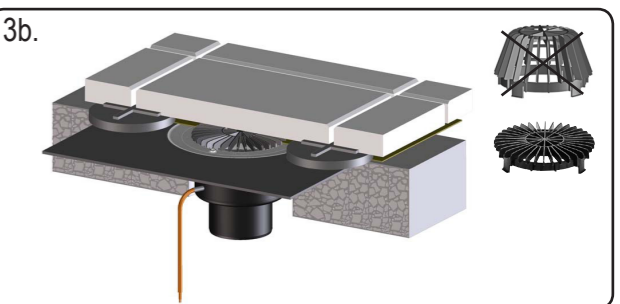
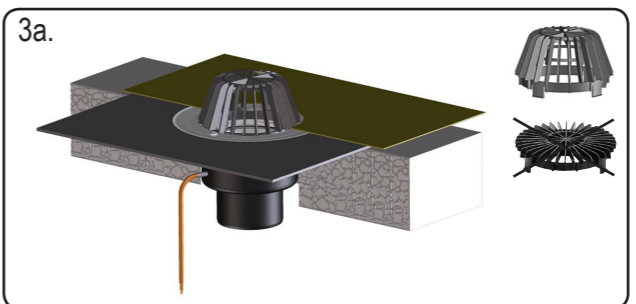
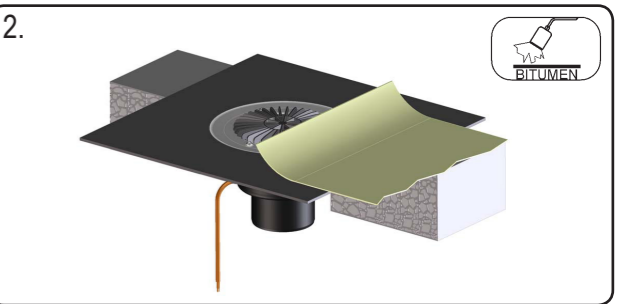
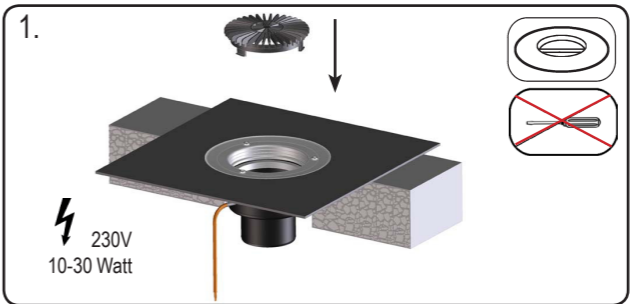
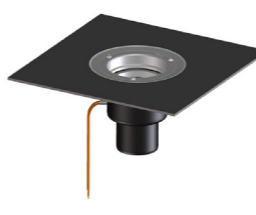

D Flachdach-Ablauf
I Scarico per tetti piani
GB Flat-roof drain
TR Düz çatı süzgeci
CZ/SK Střešní vtok
EX-YU slivnik za ravni krov
H Lapostető lefolyó
PL Wpust dachu płaskiego
SLO Odtok ravne strehe
RO Scurgere de pe terase
PYC Воронка для плоской кровли
BUL воронка за плосък покрив

14.08.2017

HL62.1H/7 9,90 l/s DN75

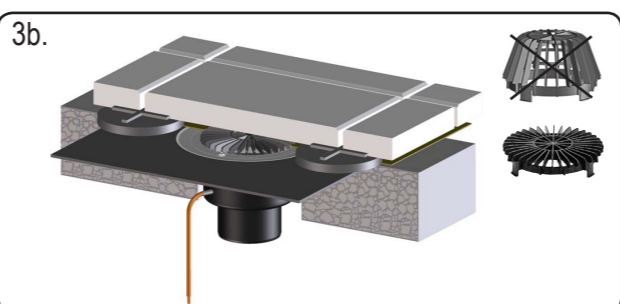
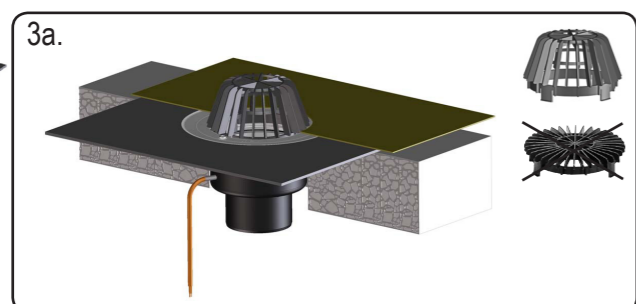
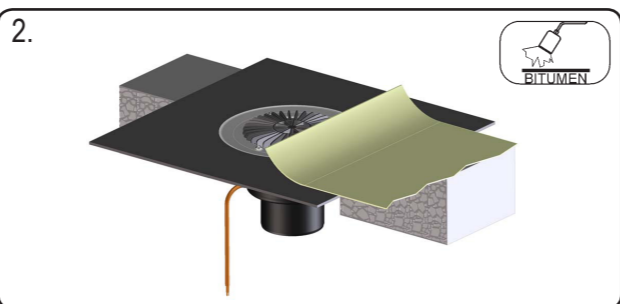
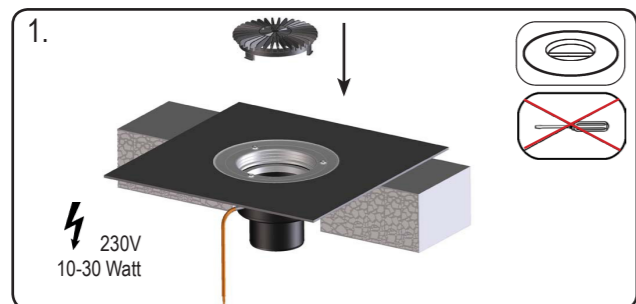
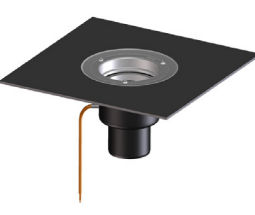

D Flachdach-Ablauf
I Scarico per tetti piani
GB Flat-roof drain
TR Düz çatı süzgeci
CZ/SK Střešní vtok
EX-YU slivnik za ravni krov
H Lapostető lefolyó
PL Wpust dachu płaskiego
SLO Odtok ravne strehe
RO Scurgere de pe terase
PYC Воронка для плоской кровли
BUL воронка за плосък покрив

14.08.2017

HL62.1H/7 9,90 l/s DN75

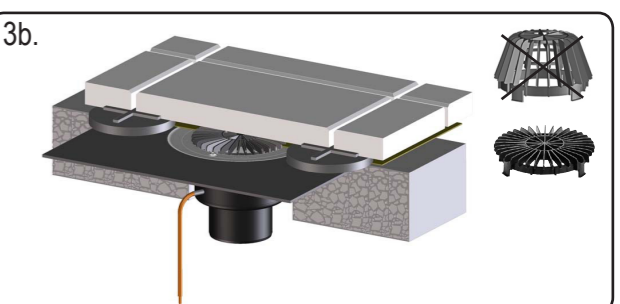
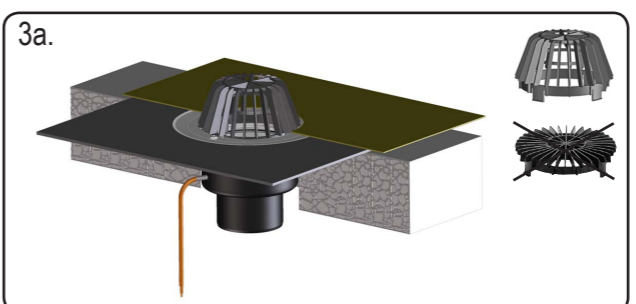
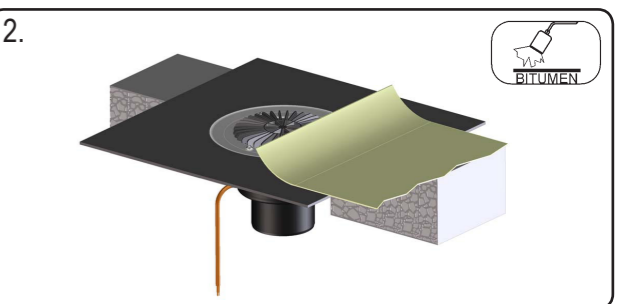
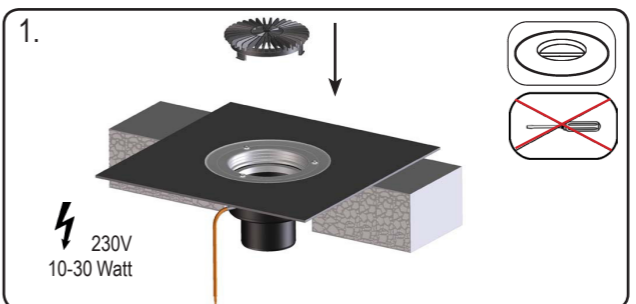
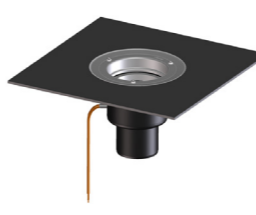

D Flachdach-Ablauf
I Scarico per tetti piani
GB Flat-roof drain
TR Düz çatı süzgeci
CZ/SK Střešní vtok
EX-YU slivnik za ravni krov
H Lapostető lefolyó
PL Wpust dachu płaskiego
SLO Odtok ravne strehe
RO Scurgere de pe terase
PYC Воронка для плоской кровли
BUL воронка за плосък покрив

14.08.2017