

HL616HS/5 5,50 l/s DN160

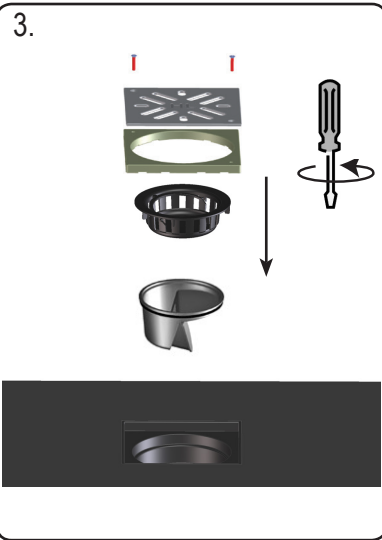
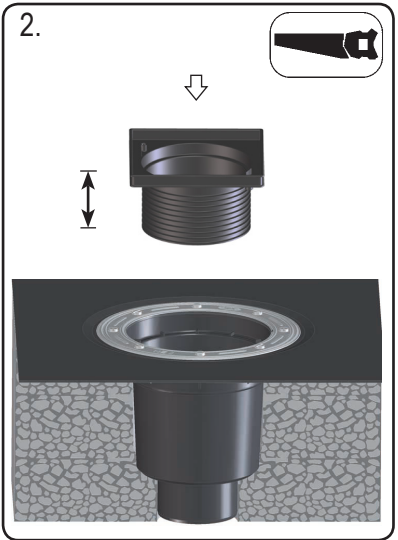
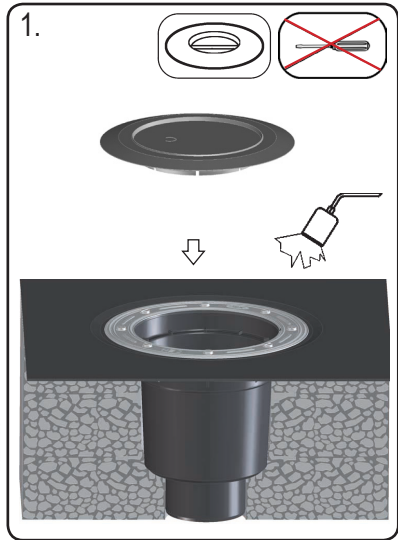
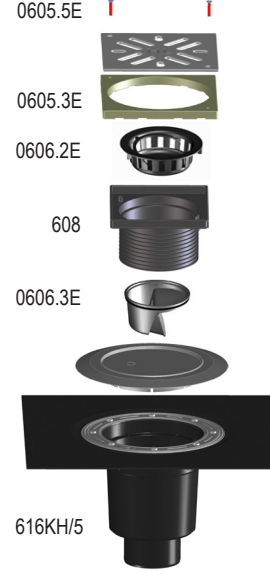
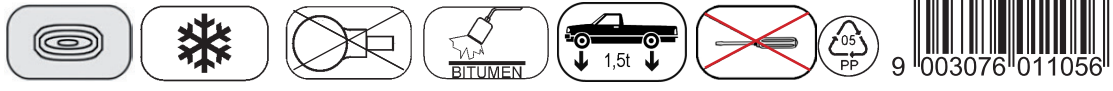

D Großablauf **TR** BÜYÜK ÇAPLI SÜZGEÇ
I GRANDO SCARICO **CZ/SK** VELKOKAPACITNÍ ODTOK
GB MAJOR DRAIN **HR** VELIK SLIVNIK
H NAGYLEFOLYÓ **RO** RECEPTOARE MARI
PL WPUST PODWÓRZOWY **PYC** Дворовый трап
SLO VELIKI ODTOK **BUL** Голям сифон

27.07.2017

HL616HS/5 5,50 l/s DN160

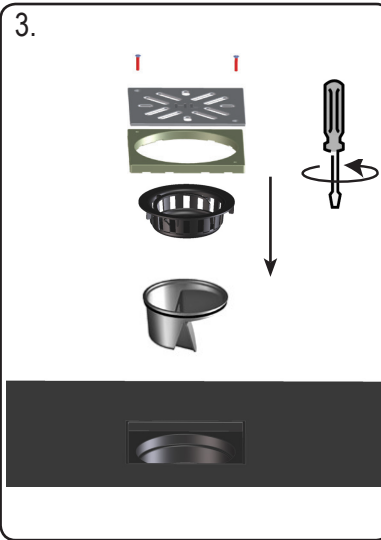
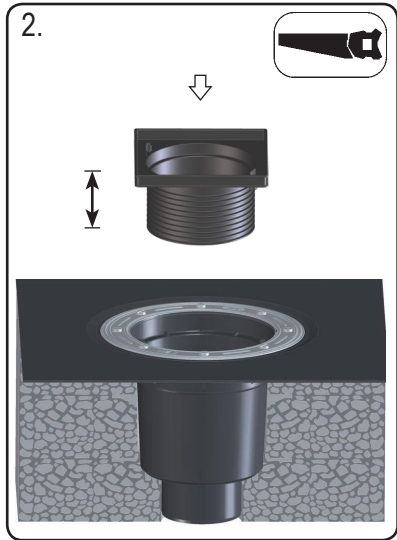
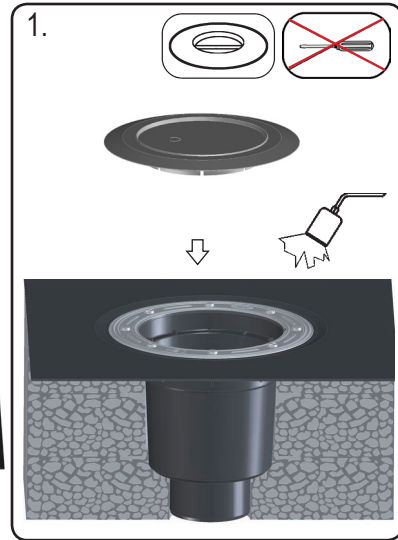
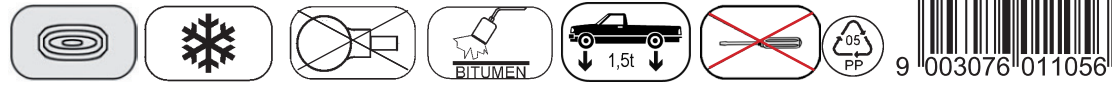

D Großablauf **TR** BÜYÜK ÇAPLI SÜZGEÇ
I GRANDO SCARICO **CZ/SK** VELKOKAPACITNÍ ODTOK
GB MAJOR DRAIN **HR** VELIK SLIVNIK
H NAGYLEFOLYÓ **RO** RECEPTOARE MARI
PL WPUST PODWÓRZOWY **PYC** Дворовый трап
SLO VELIKI ODTOK **BUL** Голям сифон

27.07.2017

HL616HS/5 5,50 l/s DN160

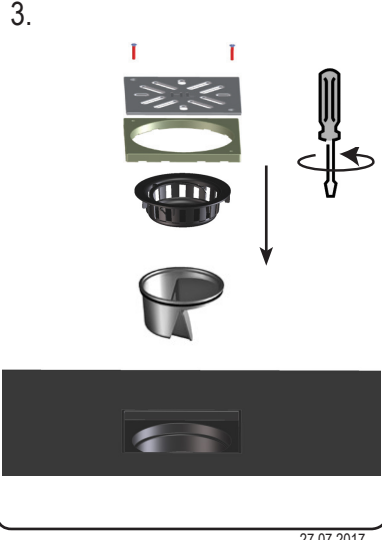
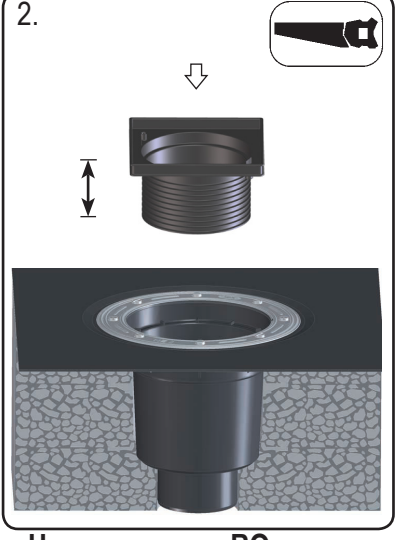
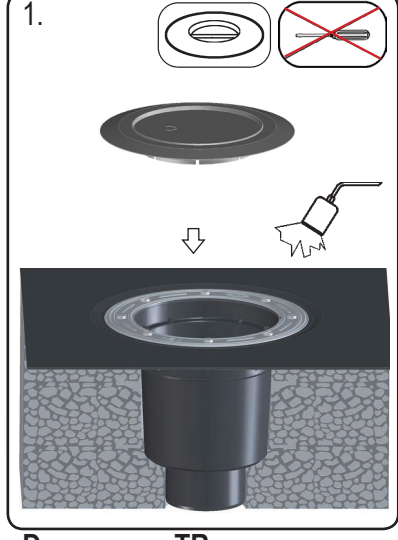
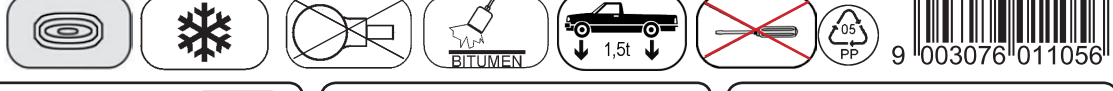

D Großablauf **TR** BÜYÜK ÇAPLI SÜZGEÇ
I GRANDO SCARICO **CZ/SK** VELKOKAPACITNÍ ODTOK
GB MAJOR DRAIN **HR** VELIK SLIVNIK
H NAGYLEFOLYÓ **RO** RECEPTOARE MARI
PL WPUST PODWÓRZOWY **PYC** Дворовый трап
SLO VELIKI ODTOK **BUL** Голям сифон

27.07.2017

HL616HS/5 5,50 l/s DN160

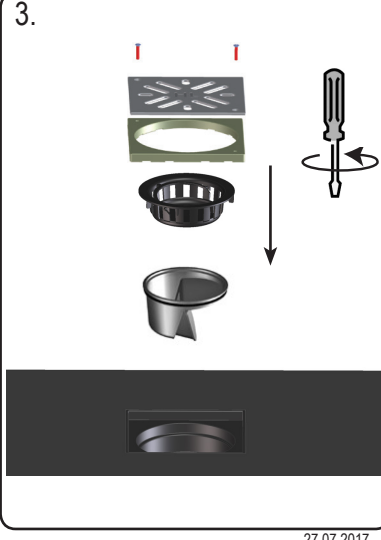
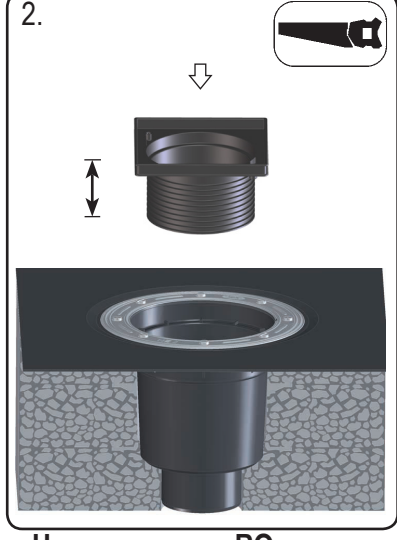
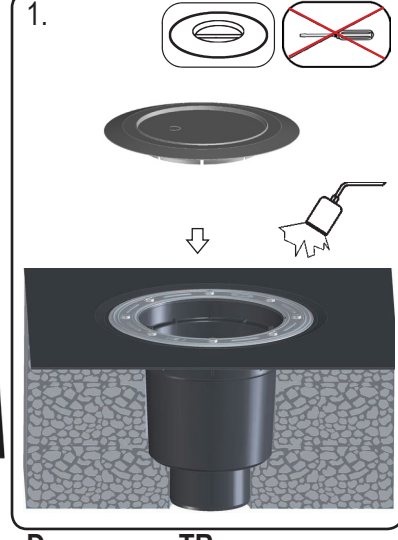

D Großablauf **TR** BÜYÜK ÇAPLI SÜZGEÇ
I GRANDO SCARICO **CZ/SK** VELKOKAPACITNÍ ODTOK
GB MAJOR DRAIN **HR** VELIK SLIVNIK
H NAGYLEFOLYÓ **RO** RECEPTOARE MARI
PL WPUST PODWÓRZOWY **PYC** Дворовый трап
SLO VELIKI ODTOK **BUL** Голям сифон

27.07.2017