

CAYONOPLAN

- floor-level shower
- classic design with inner contour
- perfect match for the CAYONO model range
- large standing area with central waste at short side
- made of KALDEWEI steel enamel



Similar illustration

	Total height	Fitting height
KA 90	105	81
KA 90 extra flat	94	70
KA 90 ultra flat	85	61
KA 90 vertical	49	81

Model 2266

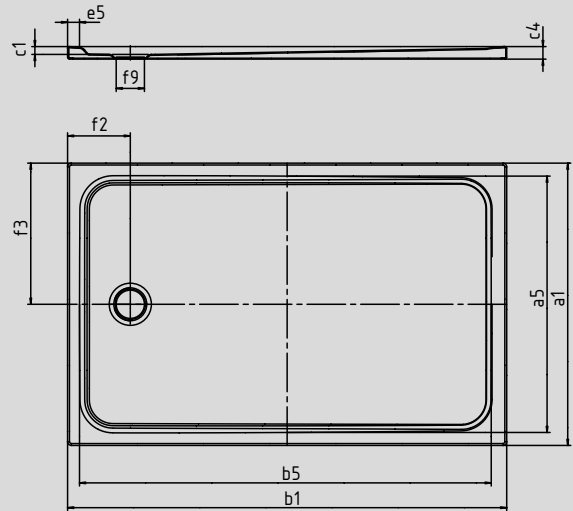

Model 2266 with low profile support

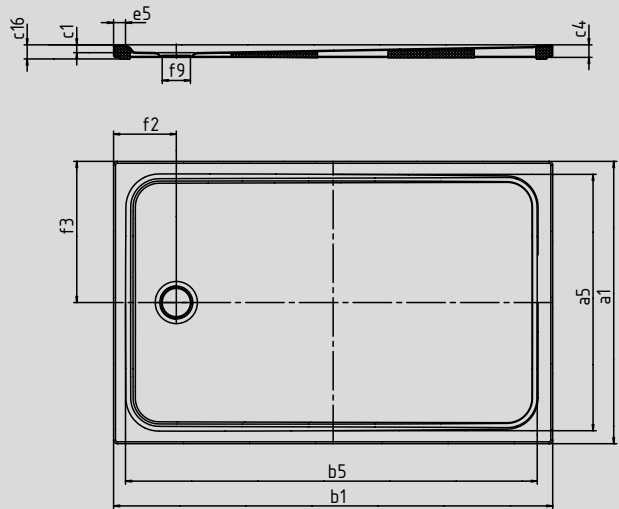

SECURE⁺

Model No.	2266	2267	
External length	a ₁	800	900 mm
Internal length	a ₅	690	790 mm
External width	b ₁	1400	1400 mm
Internal width	b ₅	1290	1290 mm
Internal depth	c ₁	25	25 mm
Height of rim	c ₄	40	40 mm
Height with support	c ₁₆	45	45 mm
Width of rim	e ₅	50	50 mm
Distance bath edge to centre of drain hole	f ₂	200	200 mm
Distance bath edge to centre of drain hole	f ₃	400	450 mm
Diameter of drain hole	f ₉	90	90 mm
Weight of the enamelled shower tray in kg		30	33
Anti-slip		555 x 855	555 x 855 mm
Full anti-slip		615 x 1235	695 x 1235 mm
SECURE PLUS		full-surface	full-surface



The German technical inspection association TÜV Rhineland has certified KALDEWEI's anti-slip, full anti-slip and SECURE PLUS finishes as having anti-slip properties compliant with:

- quality class **B** for wet barefoot areas (**DIN 51097**)
- quality class **R 10** for anti-slip characteristics in work spaces and working areas with an increased slip risk (**DIN 51130**)

All CAYONOPLAN models are available with **anti-slip, full anti-slip and SECURE PLUS**