

# CAYONOPLAN

- floor-level shower
- classic design with inner contour
- perfect match for the CAYONO model range
- large standing area with central waste at short side
- made of KALDEWEI steel enamel



Similar illustration

	Total height	Fitting height
KA 90	105	81
KA 90 extra flat	94	70
KA 90 ultra flat	85	61
KA 90 vertical	49	81

Model 2266

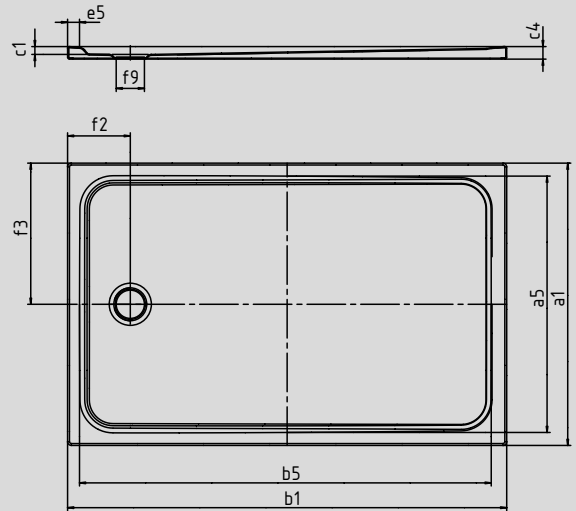

Model 2266 with low profile support

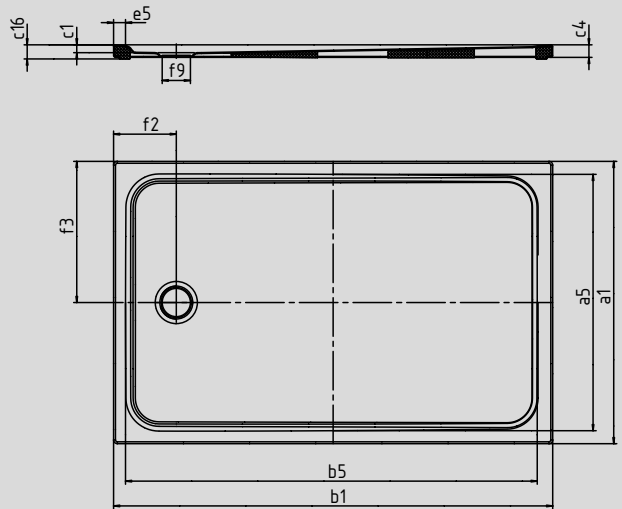

SECURE<sup>+</sup>

Model No.		2270	2271	2272	2275
External length	a <sub>1</sub>	750	800	900	750 mm
Internal length	a <sub>5</sub>	640	690	790	640 mm
External width	b <sub>1</sub>	1500	1500	1500	1600 mm
Internal width	b <sub>5</sub>	1390	1390	1390	1490 mm
Internal depth	c <sub>1</sub>	25	25	25	25 mm
Height of rim	c <sub>4</sub>	40	40	40	40 mm
Height with support	c <sub>16</sub>	45	45	45	45 mm
Width of rim	e <sub>5</sub>	50	50	50	50 mm
Distance bath edge to centre of drain hole	f <sub>2</sub>	200	200	200	200 mm
Distance bath edge to centre of drain hole	f <sub>3</sub>	375	400	450	375 mm
Diameter of drain hole	f <sub>9</sub>	90	90	90	90 mm
Weight of the enamelled shower tray in kg		30	32	36	31
Anti-slip		395 x 855	555 x 855	555 x 855	395 x 855 mm
Full anti-slip		575 x 1335	615 x 1335	695 x 1335	575 x 1435 mm
SECURE PLUS		full-surface	full-surface	full-surface	full-surface



The German technical inspection association TÜV Rhineland has certified KALDEWEI's anti-slip, full anti-slip and SECURE PLUS finishes as having anti-slip properties compliant with:

- quality class **B** for wet barefoot areas (**DIN 51097**)
- quality class **R 10** for anti-slip characteristics in work spaces and working areas with an increased slip risk (**DIN 51130**)

All CAYONOPLAN models are available with **anti-slip, full anti-slip and SECURE PLUS**