

# HLF808/909

## INSTALAČNÍ NÁVOD / INSTALLATION INSTRUCTION

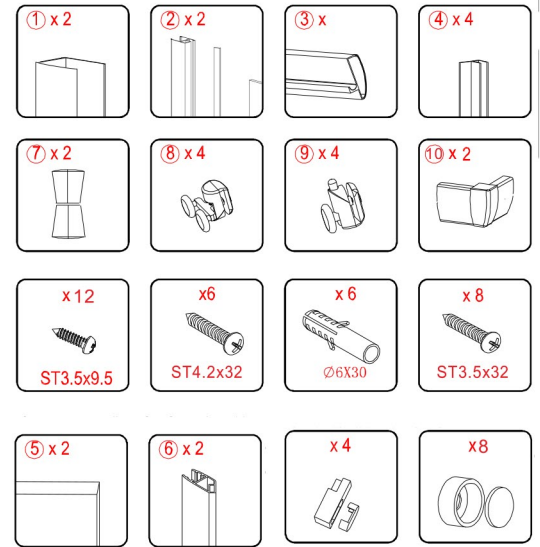

1

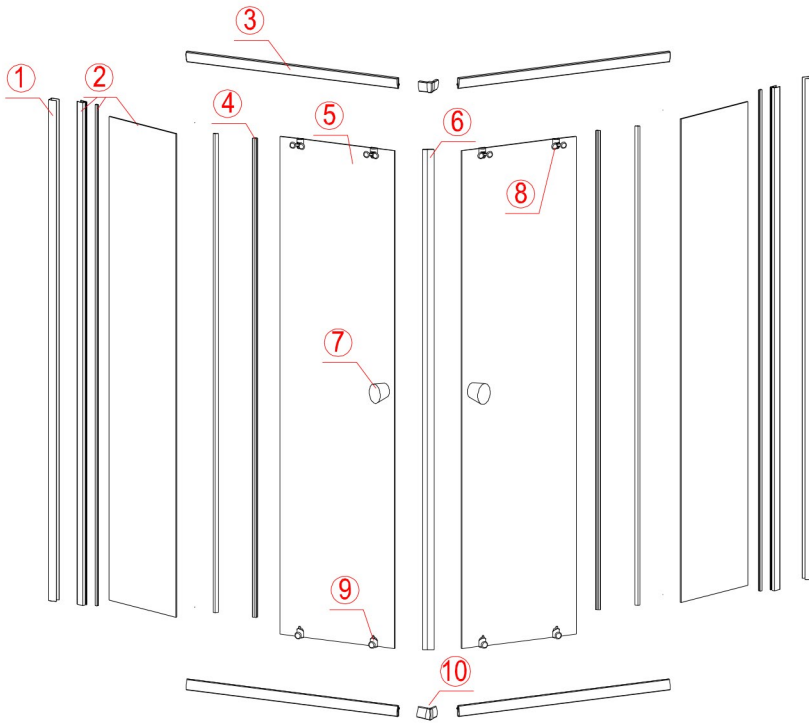
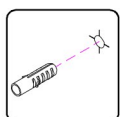
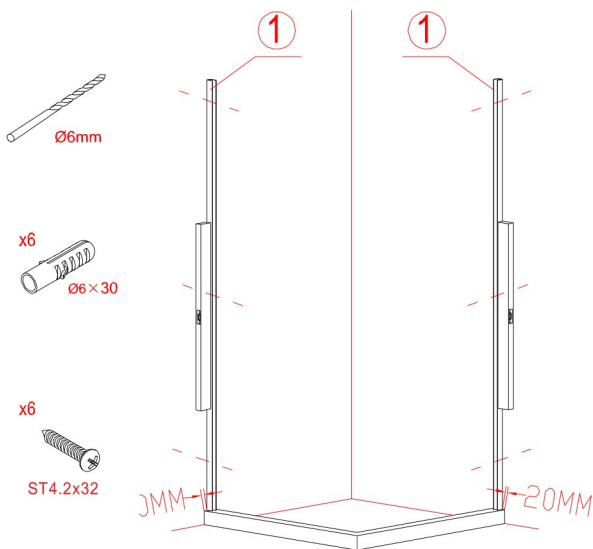

2

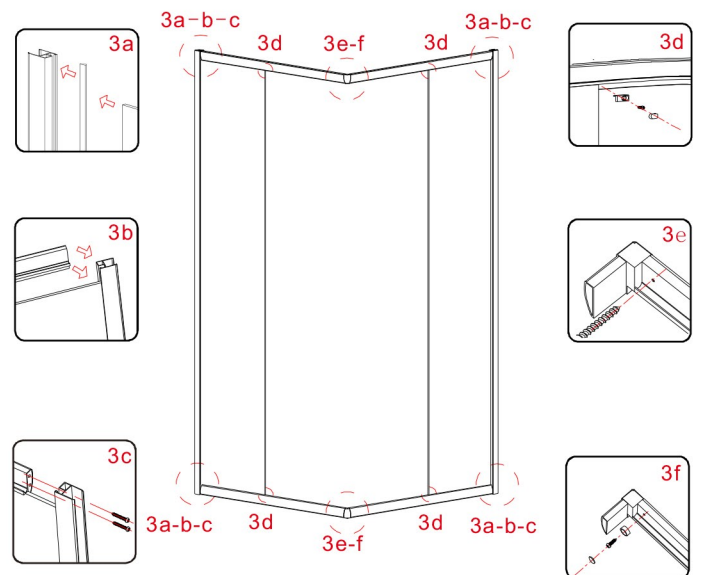

3

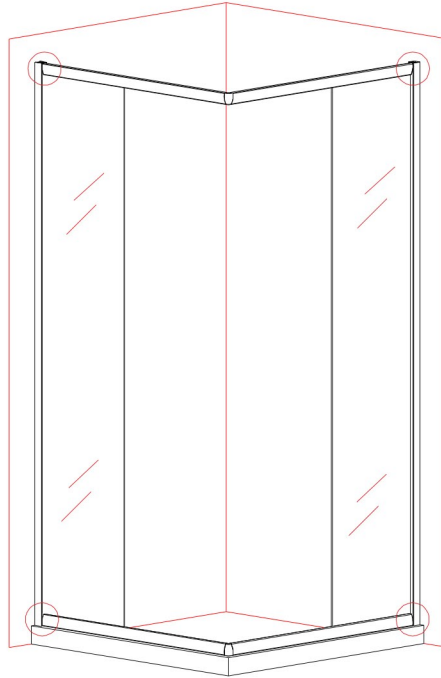
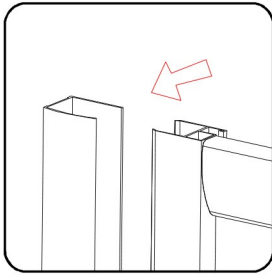

4

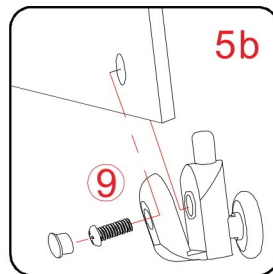
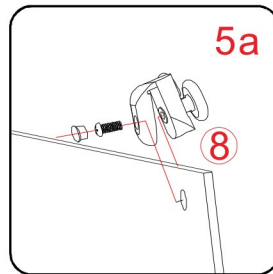
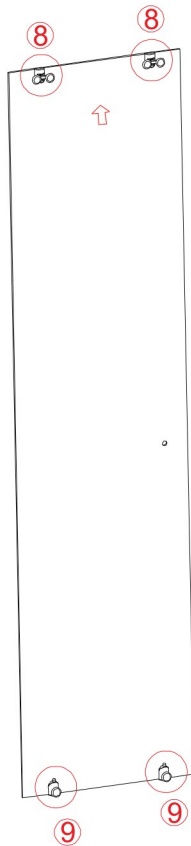

5

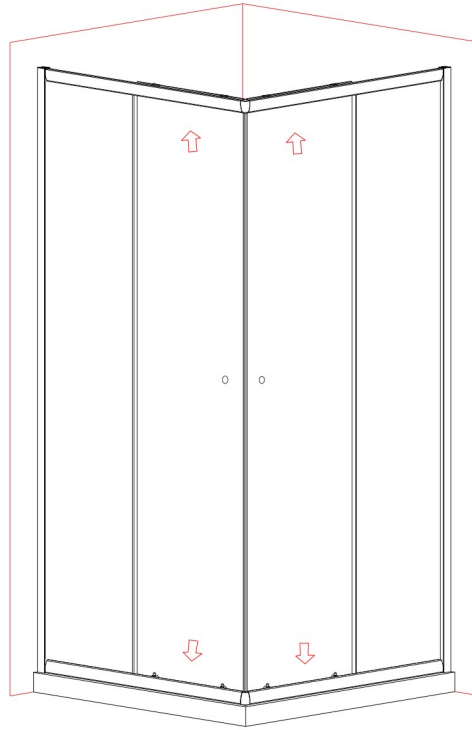
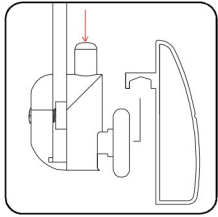
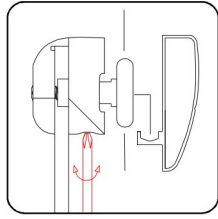

6

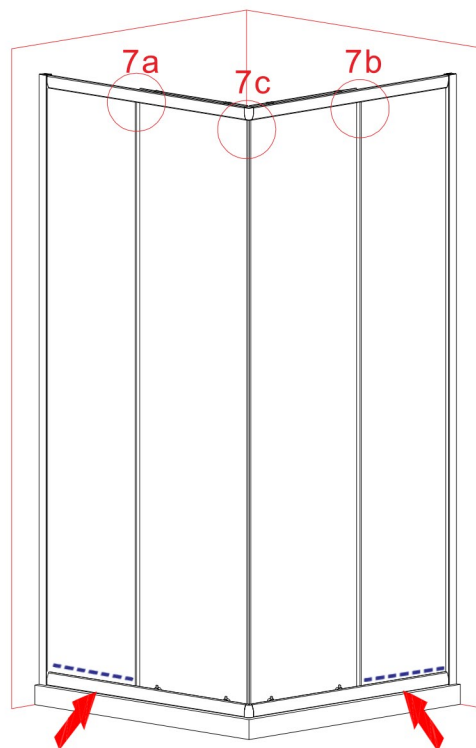
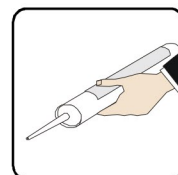
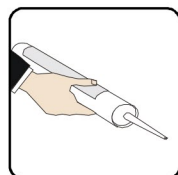
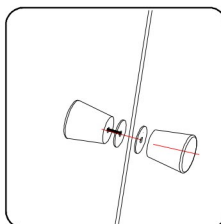
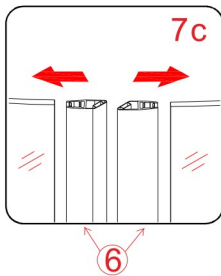
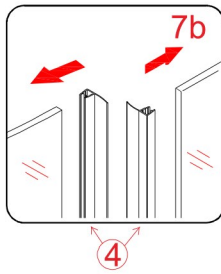
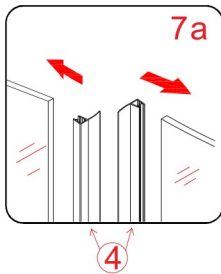

7

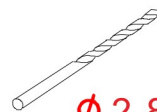
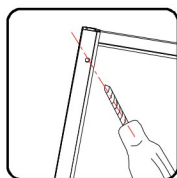
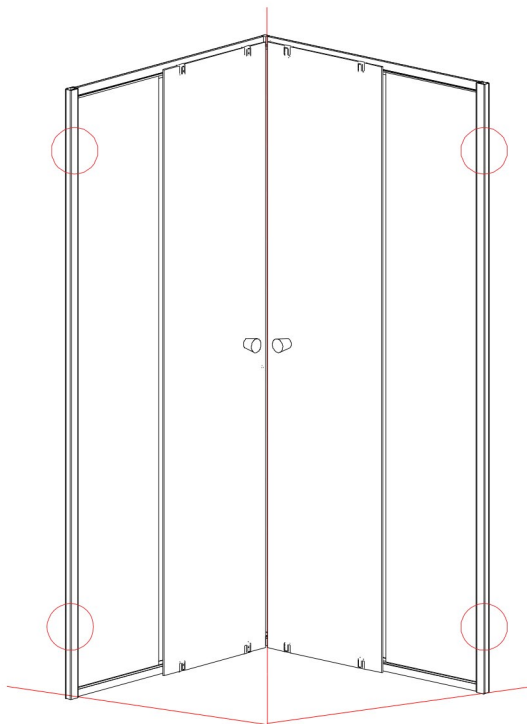

$\phi$  2.8mm

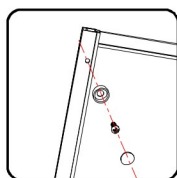

x 4



ST3.5x9.5

x 4



8

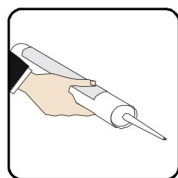
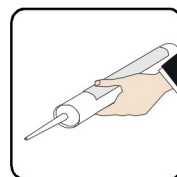
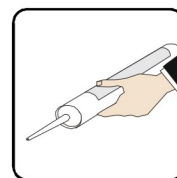
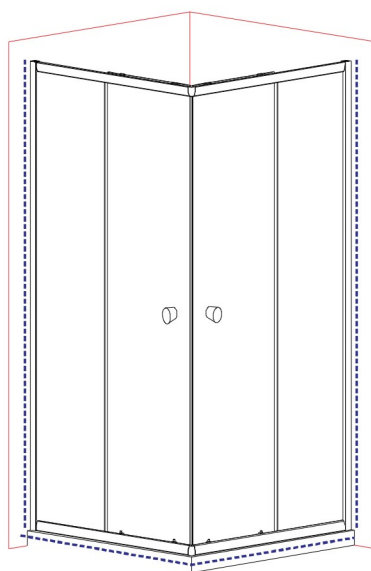
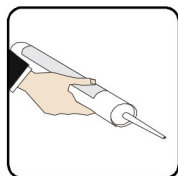
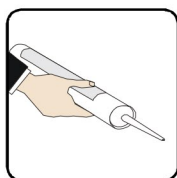

24 hodin

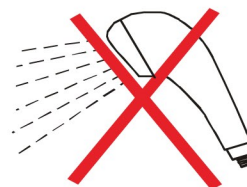

9