

# CONO COUNTERTOP WASHBASIN (RIM HEIGHT 40 MM)

- washbasin with premium character exudes elegance and harmony
- optimally integrated enamelled waste accentuates the underlying geometry of the washbasin
- unusually generous rim provides space for fittings or individual accessories
- perfectly complements the CONO range

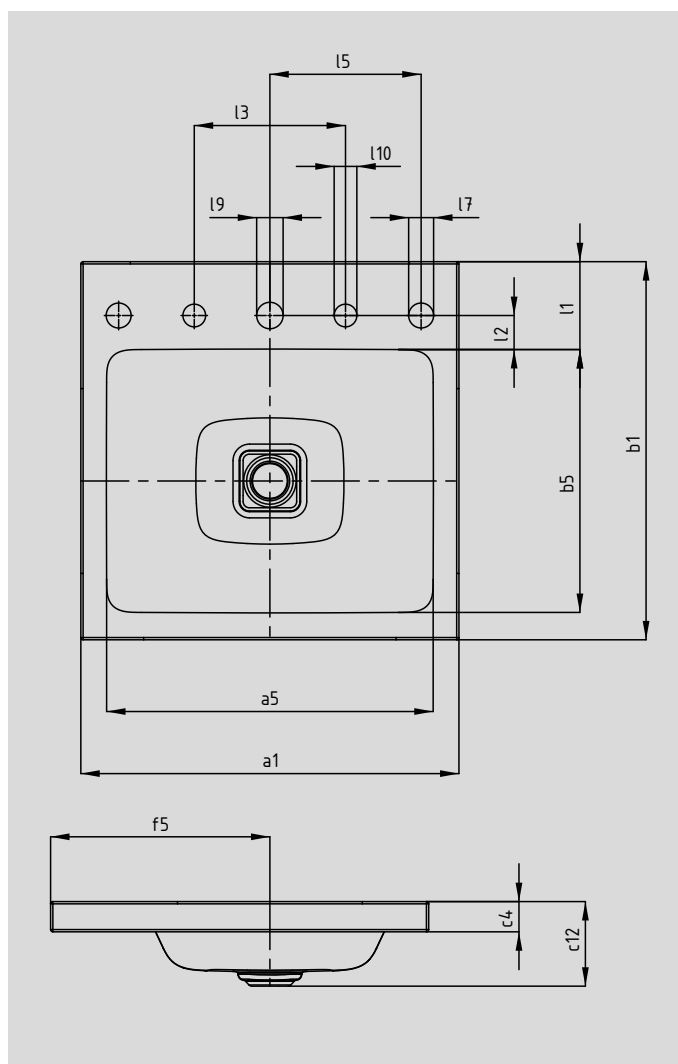

Similar illustration



Model No.		3076
External length	$a_1$	500 mm
Internal length	$a_5$	432 mm
External width	$b_1$	500 mm
Internal width	$b_5$	348 mm
Height of rim	$c_4$	40 mm
Distance basin surface to bottom edge of waste hole	$c_{12}$	112 mm
Distance outer edge to centre of waste hole	$f_5$	290 mm
Depth of tap deck	$l_1$	116 mm
Distance tap holes to edge	$l_2$	45 mm
Distance of tap holes	$l_3$	200 mm
Distance of tap hole to centre of control knob hole	$l_5$	200 mm
Diameter of control knob hole	$l_7$	33 mm
Diameter of centre tap hole	$l_9$	35 mm
Diameter of outside tap holes (3 tap holes only)	$l_{10}$	30 mm
Weight of the enamelled washbasin in kg		6,7