

AXOR

DE / Montageanleitung	02
FR / Instructions de montage	02
EN / assembly instructions	03
IT / Istruzioni per Installazione	03
ES / Instrucciones de montaje	04
NL / Handleiding	04
DK / Monteringsvejledning	05
PT / Manual de Instalação	05
PL / Instrukcja montażu	06
CS / Montážní návod	06
SK / Montážny návod	07
ZH / 组装说明	07
RU / Инструкция по монтажу	08
HU / Szerelési útmutató	08
FI / Asennusohje	09
SV / Monteringsanvisning	09
LT / Montavimo instrukcijos	10
HR / Uputstva za instalaciju	10
TR / Montaj kılavuzu	11
RO / Instrucțiuni de montare	11
EL / Οδηγία συναρμολόγησης	12
SL / Navodila za montažo	12
ET / Paigaldusjuhend	13
LV / Montāžas instrukcija	13
SR / Uputstvo za montažu	14
NO / Montasjeveiledning	14
BG / Ръководство за монтаж	15
SQ / Udhëzime rreth montimit	15
AR / تعليمات التجميع	16

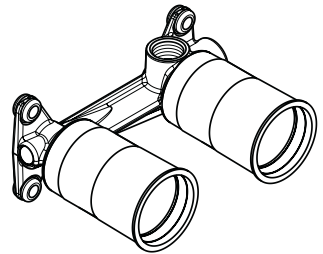

AXOR
13623180

INSTALLATION

△ SICHERHEITSHINWEISE

- △ Bei der Montage müssen zur Vermeidung von Quetsch- und Schnittverletzungen Handschuhe getragen werden.
- △ Große Druckunterschiede zwischen den Kalt- und Warmwasseranschlüssen müssen ausgeglichen werden.

MONTAGEHINWEISE

- / Vor der Montage muss das Produkt auf Transportschäden untersucht werden. Nach dem Einbau werden keine Transport- oder Oberflächenschäden anerkannt.
- / Die Leitungen und die Armatur müssen nach den gültigen Normen montiert, gespült und geprüft werden.
- / Die in den Ländern jeweils gültigen Installationsrichtlinien sind einzuhalten.

SYMBOLERKLÄRUNG

 Kein essigsäurehaltiges Silikon verwenden!

 FERTIGSET
(siehe Seite 18)

 MASSE
(siehe Seite 31)

 SERVICETEILE
(siehe Seite 31)

 PRÜFZEICHEN
(siehe Seite 31)

△ CONSIGNES DE SÉCURITÉ

- △ Lors du montage, porter des gants de protection pour éviter toute blessure par écrasement ou coupure.
- △ Il est conseillé d'équilibrer les pressions de l'eau chaude et froide.

INSTRUCTIONS POUR LE MONTAGE

- / Avant son montage, s'assurer que le produit n'a subi aucun dommage pendant le transport. Après le montage, tout dommage de transport ou de surface ne pourra pas être reconnu.
- / Les conduites et la robinetterie doivent être montés, rincés et contrôlés selon les normes en vigueur.
- / Les directives d'installation en vigueur dans le pays concerné doivent être respectées.

DESCRIPTION DU SYMBOLE

 Ne pas utiliser de silicone contenant de l'acide acétique!

 SET DE FINITION
(voir pages 18)

 DIMENSIONS
(voir pages 31)

 PIÈCES DÉTACHÉES
(voir pages 31)

 CLASSIFICATION ACOUSTIQUE
ET DÉBIT
(voir pages 31)

⚠ SAFETY NOTES

- ⚠ Gloves should be worn during installation to prevent crushing and cutting injuries.
- ⚠ The hot and cold supplies must be of equal pressures.

INSTALLATION INSTRUCTIONS

- / Prior to installation, inspect the product for transport damages. After it has been installed, no transport or surface damage will be honoured.
- / The pipes and the fixture must be installed, flushed and tested as per the applicable standards.
- / The plumbing codes applicable in the respective countries must be observed.

SYMBOL DESCRIPTION

 Do not use silicone containing acetic acid!

 FINISH SET
(see page 18)

 DIMENSIONS
(see page 31)

 SPARE PARTS
(see page 31)

 TEST CERTIFICATE
(see page 31)

⚠ INDICAZIONI SULLA SICUREZZA

- ⚠ Durante il montaggio, per evitare ferite da schiacciamento e da taglio bisogna indossare guanti protettivi.
- ⚠ Attenzione! Compensare le differenze di pressione tra i collegamenti dell'acqua fredda e dell'acqua calda.

ISTRUZIONI PER IL MONTAGGIO

- / Prima del montaggio è necessario controllare che non ci siano stati danni durante il trasporto. Una volta eseguito il montaggio, non verranno riconosciuti eventuali danni di trasporto o delle superfici.
- / Montare, lavare e controllare tubature e rubinetteria rispettando le norme correnti.
- / Vanno rispettate le direttive di installazione nazionali vigenti nel rispettivo paese.

DESCRIZIONE SIMBOLO

 Non utilizzare silicone contenente acido acetico!

 SET ESTERNO
(vedi pagg. 18)

 INGOMBRI
(vedi pagg. 31)

 PARTI DI RICAMBIO
(vedi pagg. 31)

 SEGNO DI VERIFICA
(vedi pagg. 31)

△ INDICACIONES DE SEGURIDAD

- △ Durante el montaje deben utilizarse guantes para evitar heridas por aplastamiento o corte.
- △ Grandes diferencias de presión en servicio entre agua fría y agua caliente deben equilibrarse.

INDICACIONES PARA EL MONTAJE

- / Antes del montaje se debe examinarse el producto contra daños de transporte. Después de la instalación no se reconoce ningún daño de transporte o de superficie.
- / Los conductos y la grifería deben montarse, lavarse y comprobarse según las normas vigentes.
- / Es obligatorio el cumplimiento de las directrices de instalación vigentes en el país respectivo.

DESCRIPCIÓN DE SÍMBOLOS

 No utilizar silicona que contiene ácido acético!

 EMBELLECEDOR EXTERIOR
(ver página 18)

 DIMENSIONES
(ver página 31)

 REPUESTOS
(ver página 31)

 MARCA DE VERIFICACIÓN
(ver página 31)

△ VEILIGHEIDSINSTRUCTIES

- △ Bij de montage moeten ter voorkoming van knel- en snijwonden handschoenen worden gedragen.
- △ Grote drukverschillen tussen de koud- en warmwatertoevoer dienen vermeden te worden.

MONTAGE-INSTRUCTIES

- / Vóór de montage moet het product gecontroleerd worden op transportschade. Na de inbouw wordt geen transport- of oppervlakteschade meer aanvaard.
- / De leidingen en armaturen moeten gemonteerd, gespoeld en gecontroleerd worden volgens de geldige normen.
- / De in de overeenkomstige landen geldende installatierichtlijnen moeten nageleefd worden.

SYMBOOLBESCHRIJVING

 Gebruik geen zuurhoudende silicone!

 KLEURSET
(zie blz. 18)

 MATEN
(zie blz. 31)

 SERVICE ONDERDELEN
(zie blz. 31)

 KEURMERK
(zie blz. 31)

⚠ SIKKERHEDSANVISNINGER

- ⚠ Ved monteringen skal der bruges handsker for at undgå kvæstelser og snitsår.
- ⚠ Større trykforskelle mellem koldt og varmt vand bør udjævnes.

MONTERINGSANVISNINGER

- / Før monteringen skal produktet kontrolleres for transport-skader. Efter monteringen godkendes transportskader eller skader på overfladen ikke længere.
- / Ledningerne og armaturerne skal monteres, skylles og kontrolleres iht. de gældende standarder.
- / Installationsbestemmelserne, der gælder i det enkelte land, skal overholdes.

SYMBOLBESKRIVELSE

 Der må ikke benyttes eddikesyreholdig silikone!

 KAPPESÆT
(se s. 18)

 MÅLENE
(se s. 31)

 RESERVEDELE
(se s. 31)

 GODKENDELSE
(se s. 31)

⚠ AVISOS DE SEGURANÇA

- ⚠ Durante a montagem devem ser utilizadas luvas de protecção, de modo a evitar ferimentos resultantes de entalamentos e de cortes.
- ⚠ Grandes diferenças entre as pressões das águas quente e fria devem ser compensadas.

AVISOS DE MONTAGEM

- / Antes da montagem deve-se controlar o produto relativamente a danos de transporte. Após a montagem não são aceites quaisquer danos de transporte ou de superfície.
- / As tubagens e a torneira têm que ser montadas, enxaguadas e verificadas de acordo com as normas em vigor.
- / A prescrições de instalação válidas nos respetivos países devem ser respeitadas.

DESCRIÇÃO DO SÍMBOLO

 Não utilizar silicose que contenha ácido acético!

 CONJUNTO COMPLETO
(ver página 18)

 MEDIDAS
(ver página 31)

 PEÇAS DE SUBSTITUIÇÃO
(ver página 31)

 MARCA DE CONTROLO
(ver página 31)

△ WSKAZÓWKI BEZPIECZEŃSTWA

- △ Aby uniknąć zranień na skutek zgniecenia lub przecięcia, podczas montażu należy nosić rękawice ochronne.
- △ Znaczne różnice ciśnień na dopływach ciepłej i zimnej wody muszą zostać wyrównane.

WSKAZÓWKI MONTAŻOWE

- / Przed montażem należy skontrolować produkt pod kątem szkód transportowych. Po montażu nie widać żadnych szkód transportowych ani szkód na powierzchni.
- / Przewody i armatura muszą być montowane, płukane i kontrolowane według obowiązujących norm.
- / Należy przestrzegać wytycznych instalacyjnych obowiązujących w danym kraju.

OPIS SYMBOLU

 Nie stosować silikonów zawierających kwas octowy!

 ELEMENTY ZEWNĘTRZNE
(patrz strona 18)

 WYMIARY
(patrz strona 31)

 CZĘŚCI SERWISOWE
(patrz strona 31)

 ZNAK JAKOŚCI
(patrz strona 31)

△ BEZPEČNOSTNÍ POKYNY

- △ Pro zabránění řezným zraněním a pohmožděním je nutné při montáži nosit rukavice.
- △ Je nutné vyrovnat velké rozdíly tlaku mezi přípoji studené a teplé vody.

POKYNY K MONTÁŽI

- / Před montáží je třeba produkt zkontrolovat, zda nebyl při transportu poškozen. Po zabudování nebudou uznány žádné škody způsobené transportem nebo poškození povrchu.
- / Vedení a armatura musí být namontovány, propláchnuty a otestovány podle platných norem.
- / Je třeba dodržovat montážní pravidla platné v dané zemi.

POPIS SYMBOLŮ

 Nepoužívat silikon s obsahem kyseliny octové!

 VRCHNÍ SADA
(viz strana 18)

 ROZMĚRY
(viz strana 31)

 SERVISNÍ DÍLY
(viz strana 31)

 ZKUŠEBNÍ ZNAČKA
(viz strana 31)

△ BEZPEČNOSTNÉ POKYNY

- △ Pri montáži musíte nosiť rukavice, aby ste predišli poškodeniam a rezným poraneniam.
- △ Veľké rozdiely v tlaku medzi prípojkami studenej a teplej vody musia byť vyrovnané.

POKYNY PRE MONTÁŽ

- / Pred montážou musíte produkt skontrolovať, či nebol počas transportu poškodený. Po zabudovaní nebudú uznané žiadne škody spôsobené transportom alebo poškodenia povrchu.
- / Ledningarna och blandaren måste monteras, spolas igenom och kontrolleras enligt de gällande normerna.
- / Je potrebné dodržiavať smernice o inštalácii, ktoré sú práve teraz platné v krajinách.

POPIS SYMBOLOV

 Nepoužívať silikón s obsahom kyseliny octovej!

 VRCHNÁ SADA
(viď strana 18)

 ROZMERY
(viď strana 31)

 SERVISNÉ DIELY
(viď strana 31)

 OSVEDČENIE O SKÚŠKE
(viď strana 31)

△ 安全技巧

- △ 装配时为避免挤压和切割受伤，必须戴上手套。
- △ 冷热水管间过大的压力差必须予以平衡。

安装提示

- / 安装前必须检查产品是否受到运输损害。安装后将不认可运输损害或表面损伤。
- / 管道和阀门必须根据通用标准进行安装、冲洗和检查。
- / 请遵守当地国家现行的安装规定。

符号说明

 请勿使用含有乙酸的硅胶！

 加工件
(参见第页 18)

 大小
(参见第页 31)

 备用零件
(参见第页 31)

 检验标记
(参见第页 31)

▲ УКАЗАНИЯ ПО ТЕХНИКЕ БЕЗОПАСНОСТИ

- ▲ Во время монтажа следует надеть перчатки во избежание прищемления и порезов.
- ▲ донного клапа. Перед установкой смесителя необходимо регулировочными кранами выровнять давление холодной и горячей воды при помощи вентилей регулирующих подачу воды в квартиру.

УКАЗАНИЯ ПО МОНТАЖУ

- / Перед монтажом следует проверить изделие на предмет повреждений при перевозке. После монтажа претензии о возмещении ущерба за повреждения при перевозке или повреждения поверхностей не принимаются.
- / Трубы и арматура должны быть установлены, промыты и проверены в соответствии с действующими нормами.
- / Необходимо соблюдать требования по монтажу, действующие в соответствующих странах.

ОПИСАНИЕ СИМВОЛОВ

 Не применяйте силикон, содержащий уксусную кислоту.

 НАРУЖНАЯ ЧАСТЬ
(см. стр. 18)

 РАЗМЕРЫ
(см. стр. 31)

 КОМПЛЕКТ
(см. стр. 31)

 ЗНАК ТЕХНИЧЕСКОГО КОНТРОЛЯ
(см. стр. 31)

▲ BIZTONSÁGI UTASÍTÁSOK

- ▲ A szerelésnél a zúzódások és vágási sérülések elkerülése érdekében kesztyűt kell viselni.
- ▲ A hidegvíz- és a melegvíz-csatlakozások közötti nagy nyomáskülönbséget kikell egyenlíteni!

SZERELÉSI UTASÍTÁSOK

- / A szerelés előtt ellenőrizni kell, hogy a terméknek nincs-e szállítási sérülése. Beépítés után a szállítási- vagy felületi sérüléseket nem ismerik el.
- / A vezetékeket és a csaptetelepet az érvényes szabványoknak megfelelően kell felszerelni, öblíteni és ellenőrizni
- / Az egyes országokban érvényes installációs irányelveket be kell tartani.

SZIMBÓLUMOK LEÍRÁSA

 Ne használjon ecetsavtartalmú szilikont!

 A KÉSZ SZERELVÉNY
(lásd a oldalon 18)

 MÉRETET
(lásd a oldalon 31)

 TARTOZÉKOK
(lásd a oldalon 31)

 VIZSGAJEL
(lásd a oldalon 31)

△ TURVALLISUUSOHJEET

- △ Asennuksessa on käytettävä käsineitä puristumien ja villojen aiheuttamien tapaturmien estämiseksi.
- △ Suuret paine-erot kylmä- ja kuumavesiliitäntöjen välillä on tasattava.

A SENNUSOHJEET

- / Ennen asennusta on tarkastettava tuotteen mahdolliset kuljetusvahingot. Asennuksen jälkeen kuljetus- ja pintavaurioita ei hyväksytä.
- / Putket ja hana on asennettava, huuhdeltava ja tarkastettava voimassa olevien standardien mukaisesti.
- / Jokaisessa maassa on noudatettava siellä päteviä asennusohjeita.

△ SÄKERHETSANVISNINGAR

- △ Handskar ska bäras under monteringsarbetet så att man kan undvika kläm- och skärskadorgen werden.
- △ Stora tryckskillnader mellan anslutningarna för varmt och kallt vatten måste utjämnas.

MONTERINGSANVISNINGAR

- / Det måste undersökas om produkten har transportskador innan den monteras. Efter monteringen accepteras inga transport- eller ytskiktsskador.
- / Ledningarna och blandaren måste monteras, spolas igenom och kontrolleras enligt de gällande normerna.
- / De installationsriktlinjer som gäller i länderna ska följas.

MERKIN KUVAUS

 Älä käytä etikahappopitoista silikoniala

 VALMISSARJA
(katso sivu 18)

 MITAT
(katso sivu 31)

 VARAOSAT
(katso sivu 31)

 KOESTUSMERKKI
(katso sivu 31)

SYMBOLFÖRKLARING

 Använd inte silikon som innehåller ättiksyra!

 FÄRDIGSET
(se sidan 18)

 MÅTTEN
(se sidan 31)

 RESERVDLAR
(se sidan 31)

 TESTSIGILL
(se sidan 31)

SAUGUMO TECHNIKOS NURODYMAI

- △ Apsaugai nuo užspaudimo ir įsijovimo montavimo metu mūvėkite pirštines.
- △ Turi būti išlyginti šalto ir karšto slėgio nelygumai.

MONTAVIMO INSTRUKCIJA

- / Prieš montuojant būtina patikrinti, ar gaminyje nebuvo pažeistas transportavimo metu. Sumontavus pretenzijos dėl transportavimo ir paviršiaus pažeidimų nepriimamos.
- / Vamzdžiai ir sujungimai turi būti montuojami, plaunami ir tikrinami pagal galiojančias normas.
- / Laikykitės atitinkamoje šalyje galiojančių direktyvų dėl įrengimo.

SIMBOLIO APRAŠYMAS

 Nenaudokite silikono, kurio sudėtyje yra acto rūgšties!

 VIRŠTINKINĖ
(žr. psl. 18)

 IŠMATAVIMAI
(žr. psl. 31)

 ATSARGINĖS DALYS
(žr. psl. 31)

 BANDYMO PAŽYMA
(žr. psl. 31)

SIGURNOSNE UPUTE

- △ Prilikom montaže se radi sprječavanja prignječenja i posjekotina moraju nositi rukavice.
- △ Velika razlika u pritisku između vruće i hladne vode mora biti izbalansirana.

UPUTE ZA MONTAŽU

- / Prije montaže mora se provjeriti je li proizvod oštećen prilikom transporta. Nakon ugradnje se ne priznaju nikakve reklamacije koje se odnose na površinska i transportna oštećenja.
- / Cijevi i armatura moraju biti postavljeni, isprani i testirani prema važećim normama.
- / Obvezno se moraju uvažiti propisi o instalacijama koji vrijede u dotičnoj zemlji.

OPIS SIMBOLA

 Nemojte koristiti silikon koji sadrži octenu kiselinu!

 ZAVRŠNI SET
(pogledaj stranicu 18)

 MJERE
(pogledaj stranicu 31)

 REZERVNI DJELOVI
(pogledaj stranicu 31)

 OZNAKA TESTIRANJA
(pogledaj stranicu 31)

△ GÜVENLİK UYARILARI

- △ Montaj esnasında ezilme ve kesilme gibi yaralanmaları önlemek için eldiven kullanılmalıdır.
- △ Sıcak ve soğuk su bağlantıları arasında büyük basınç farklılıkları varsa, bu basınç farklılıklarının dengelenmesi gerekir.

MONTAJ AÇIKLAMALARI

- / Montaj işleminden önce ürün nakliye hasarları yönünden kontrol edilmelidir. Montaj işleminden sonra nakliye veya yüzey hasarları için sorumluluk üstlenilmemektedir.
- / Boruların ve armatürün montajı, yıkanması ve kontrolü geçerli normlara göre yapılmalıdır.
- / Ülkelerde geçerli kurulum yönetmeliklerine riayet edilmelidir.

SİMGE AÇIKLAMASI

 Asetik asit içeren silikon kullanmayın!

 DIŞI SET
(bakınız sayfa 18)

 ÖLÇÜLERİ
(bakınız sayfa 31)

 YEDEK PARÇALAR
(bakınız sayfa 31)

 KONTROL İŞARETİ
(bakınız sayfa 31)

△ INSTRUCȚIUNI DE SIGURANȚĂ

- △ La montare utilizați mănuși pentru evitarea contuziunilor și tăierii mâinilor.
- △ Diferențele de presiune mari între alimentarea cu apă rece și apă caldă trebuie echilibrate.

INSTRUCȚIUNI DE MONTARE

- / Înainte de instalare verificați, dacă produsul prezintă deteriorări de transport. După instalare garanția nu acoperă deteriorările de transport și cele de suprafață.
- / Conductele și bateriile trebuie montate, spălate și verificate conform normelor în vigoare.
- / Respectați reglementările referitoare la instalare valabile în țara respectivă.

DESCRIEREA SIMBOLURILOR

 Nu utilizați silicon cu conținut de acid acetic!

 SET COMPLET
(vezi pag. 18)

 DIMENSIUNI
(vezi pag. 31)

 PIESE DE SCHIMB
(vezi pag. 31)

 CERTIFICAT DE TESTARE
(vezi pag. 31)

⚠ ΥΠΟΔΕΙΞΕΙΣ ΑΣΦΑΛΕΙΑΣ

- ⚠ Για να αποφύγετε τραυματισμούς κατά τη συναρμολόγηση πρέπει να φοράτε γάντια.
- ⚠ Οι διαφορές της πίεσης μεταξύ της σύνδεσης κρύου και ζεστού νερού θα πρέπει να αντισταθμίζονται.

ΟΔΗΓΙΕΣ ΣΥΝΑΡΜΟΛΟΓΗΣΗΣ

- / Πριν τη συναρμολόγηση πρέπει να εξεταστεί το προϊόν για ζημιές μεταφοράς. Μετά την εγκατάσταση δεν αναγνωρίζονται ζημιές από τη μεταφορά ή επιφανειακές ζημιές.
- / Οι σωλήνες και η μπαταρία πρέπει να τοποθετηθούν σύμφωνα με τα ισχύοντα πρότυπα, να τεθούν υπό πίεση και να δοκιμαστούν.
- / Θα πρέπει να τηρούνται οι οδηγίες εγκατάστασης που ισχύουν σε κάθε κράτος.

ΠΕΡΙΓΡΑΦΗ ΣΥΜΒΟΛΩΝ

 Μην χρησιμοποιείτε σιλικόνη που περιέχει οξικό οξύ!

 ΣΕΤ ΜΗΧΑΝΙΣΜΟΥ
(βλ. Σελίδα 18)

 ΔΙΑΣΤΑΣΕΙΣ
(βλ. Σελίδα 31)

 ΑΝΤΑΛΛΑΚΤΙΚΑ
(βλ. Σελίδα 31)

 ΣΗΜΑ ΕΛΕΓΧΟΥ
(βλ. Σελίδα 31)

⚠ VARNOSTNA OPOZORILA

- ⚠ Pri montaži je treba nositi rokavice, da se preprečijo poškodbe zaradi zmečkanja ali urezov.
- ⚠ Velike razlike v tlaku med priključkom za mrzlo in priključkom za toplo vodo je potrebno izravnati.

NAVODILA ZA MONTAŽO

- / Pred montažo je treba izdelek preveriti glede morebitnih transportnih poškodb. Po vgradnji transportne ali površinske poškodbe ne bodo več priznane.
- / Cevi in armaturo je treba montirati, izprati in preveriti po veljavnih standardih.
- / Upoštevati je treba pravilnike o inštalacijah, ki veljajo v posamezni državi.

OPIS SIMBOLA

 Ne smete uporabiti silikona, ki vsebuje ocatno kislino!

 ZAKLJUČNA GARNITURA
(glejte stran 18)

 MERE
(glejte stran 31)

 REZERVNI DELI
(glejte stran 31)

 PRESKUSNI ZNAK
(glejte stran 31)

△ OHUTUSJUHISED

- △ Kandke paigaldamisel muljumis- ja löikevigastuste vältimiseks kindaid.
- △ Kui külma ja kuuma vee ühenduste surve on väga erinev, tuleb need tasakaalustada.

PAIGALDAMISJUHISED

- / Enne paigaldamist tuleb toodet kontrollida transpordikahjustuste osas. Pärast paigaldamist ei tunnustata enam transpordi- või pinnakahjustuste kaebuseid.
- / Voolikute ja segisti paigaldamisel, loputamisel ja kontrollimisel tuleb lähtuda kehtivatest normatiividest.
- / Vastavas riigis kehtivaid paigalduseeskirju tuleb järgida.

△ DROŠĪBAS NORĀDES

- △ Montāžas laikā, lai izvairītos no saspiedumiem un iegriezumiem, nepieciešams nēsāt cimdus.
- △ Jāizlīdzina spiediena atšķirības starp aukstā un karstā ūdens pievadiem.

NORĀDĪJUMI MONTĀŽAI

- / Pirms montāžas nepieciešams pārbaudīt, vai produktam transportēšanas laikā nav radušies bojājumi. Pēc iebūvēšanas bojājumi, kas radušies transportēšanas laikā, vai virsmas bojājumi netiek atzīti.
- / Caurulvadi un armatūra ir jāuzstāda, jāizskalo un jāpārbauda saskaņā ar spēkā esošajiem standartiem.
- / Jāievēro attiecīgās valstīs spēkā esošās montāžas prasības.

SŪMBOLITE KIRJELDUS

 Ärge kasutage äädikhapet sisaldavat silikooni!

 VALMISKOMPLEKT
(vt lk 18)

 MÕÖTUDE
(vt lk 31)

 VARUOSAD
(vt lk 31)

 KONTROLLSERTIFIKAAT
(vt lk 31)

SIMBOLU NOZĪME

 Neizmantoj silikonu, kas satur etiķskābi!

 KOMPLEKTS
(skat. lpp. 18)

 IZMĒRUS
(skat. lpp. 31)

 REZERVES DAĻAS
(skat. lpp. 31)

 PĀRBAUDES ZĪME
(skat. lpp. 31)

△ SIGURNOSNE NAPOMENE

- △ Prilikom montaže se radi sprečavanja prignječenja i posekotina moraju nositi rukavice.
- △ Velika razlika u pritisku između vruće i hladne vode mora biti izbalansirana.

INSTRUKCIJE ZA MONTAŽU

- / Pre montaže se mora proveriti da li je proizvod oštećen pri transportu. Nakon ugradnje se ne priznaju nikakve reklamacije koje se odnose na površinska i transportna oštećenja.
- / Vodovi i armatura moraju biti postavljeni, isprani i testirani prema važećim normama.
- / Treba se pridržavati propisa koji u određenim zemljama važe za instalacije.

OPIS SIMBOLA

 Nemojte koristiti silikon koji sadrži sirćetnu kiselinu!

 ZAVRŠNI SET
(vidi stranu 18)

 MERE
(vidi stranu 31)

 REZERVNI DELOVI
(vidi stranu 31)

 ISPITNI ZNAK
(vidi stranu 31)

△ SIKKERHETSHENVISNINGER

- △ Bruk hansker under montasjen for å unngå klem- og kuttskader.
- △ Store trykkdifferanser mellom kaldt- og varmtvannstilkoblinger skal utlignes.

MONTAGEHENVISNINGER

- / Før montasjen skal produktet sjekkes for transportskader. Etter monteringen aksepteres ikke noen transport- eller overflateskader.
- / Ledningene og armaturen skal monteres, spyles og sjekkes iht. de gyldige normer.
- / Gjeldende retningslinjer for rørleggerarbeid i de enkelte land skal følges.

SYMBOLBESKRIVELSE

 Ikke bruk silikon som inneholder eddiksyre!

 FERDIGSETT
(se side 18)

 MÅL
(se side 31)

 SERVICEDELER
(se side 31)

 PRØVEMERKE
(se side 31)

⚠ УКАЗАНИЯ ЗА БЕЗОПАСНОСТ

- ⚠ При монтажа трябва да се носят ръкавици, за да се избегнат наранявания поради притискане или порязване.
- ⚠ Големите разлики в налягането между изводите за студената и топлата вода трябва да се изравняват.

УКАЗАНИЯ ЗА МОНТАЖ

- / Преди монтажа продуктът трябва да се провери за транспортни щети. След монтажа не се признават транспортни или повърхностни щети.
- / Тръбопроводите и арматурата трябва да се монтират, промият и проверят в съответствие с валидните норми.
- / Трябва да бъдат спазвани валидните в съответните страни предписания за инсталиране.

⚠ UDHËZIME SIGURIE

- ⚠ Për të evituar lëndimet e pickimeve ose të prerjeve gjatë procesit të montimit duhet që të vishni doreza.
- ⚠ Ndryshimet e mëdha të presionit mes lidhjeve të ujit të ftohtë dhe atij të ngrohtë duhen ekuilibruar.

UDHËZIME PËR MONTIMIN

- / Përpara montimit duhet që produkti të kontrollohet për dëmtime nga transporti. Pas instalimit nuk do të njihet asnjë dëmtim nga transporti ose dëmtim i sipërfaqes.
- / Tubacionet dhe rubinetet duhet që të montohen, të shpëlahen dhe të kontrollohen sipas standardeve në fuqi
- / Duhet të respektohen linjat udhëzuese të instalimit, të vlefshme për vendet respektive.

ОПИСАНИЕ НА СИМВОЛИТЕ

 Не използвайте силикон, съдържащ оцетна киселина!

 ГОТОВ НАБОР
(вижте стр. 18)

 РАЗМЕРИ
(вижте стр. 31)

 СЕРВИЗНИ ЧАСТИ
(вижте стр. 31)

 КОНТРОЛЕН ЗНАК
(вижте стр. 31)

PËRSHKRIMI I SIMBOLIT

 Mos përdorni silikon që në përbërje ka acid acetik.

 KOMPLET I GATSHËM
(shih faqen 18)

 PËRMASAT
(shih faqen 31)

 PJESËT E SERVISIT
(shih faqen 31)

 SHENJA E KONTROLLIT
(shih faqen 31)

⚠ تنبيهات الأمان

⚠ يجب إرتداء قفازات لليد أثناء التركيب لتجنب حدوث أخطار الإنحشار أو الجروح.

⚠ يجب أن يكون تيار الماء الساخن والماء البارد متعادلين في الضغط.

تعليمات التركيب

/ قبل القيام بعملية التركيب، يجب فحص المنتج للتأكد من خلوه من أية تلفيات ناتجة عن النقل. بعد القيام بعملية التركيب، لن يتم الاعتراف بوجود أية تلفيات سطحية أو تلفيات ناتجة عن عملية النقل.

/ يجب تركيب وغسيل واختبار التوصيلات وخلطات المياه طبقاً للمعايير السارية.

/ يجب مراعاة القواعد الخاصة بالتركيب وأعمال السباكة وفقاً للوائح الخاصة بكل بلد.

وصف الرمز

هام! لا تستخدم السليكون الذي يحتوي على أحماض! 

مجموعة كاملة. 
(راجع صفحة 18)

أبعاد 
(راجع صفحة 31)

قطع الغيار 
(راجع صفحة 31)

شهادة اختبار 
(راجع صفحة 31)

التركيب (راجع صفحة 17) 

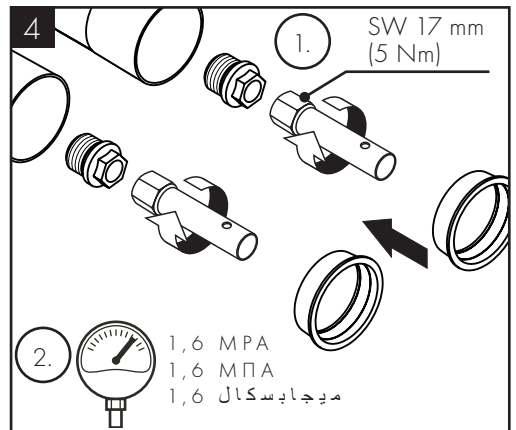
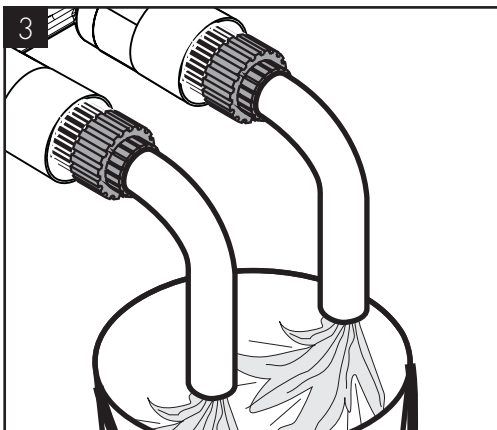
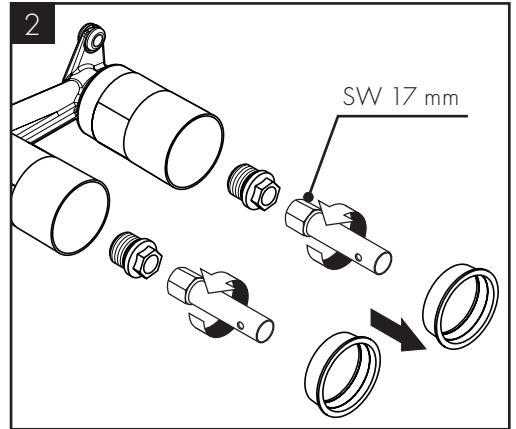
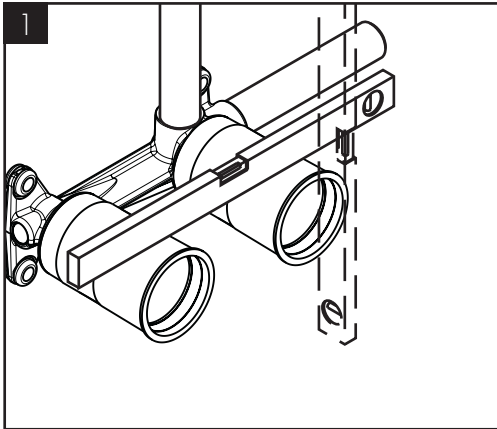
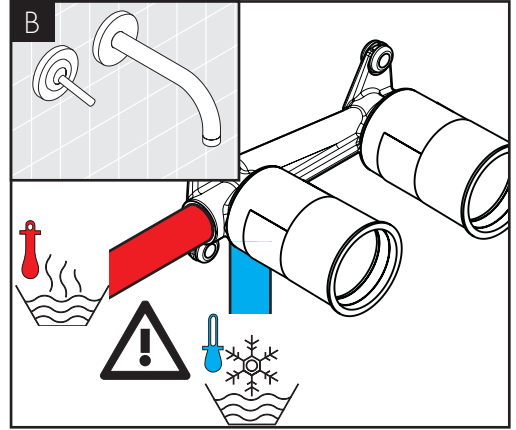
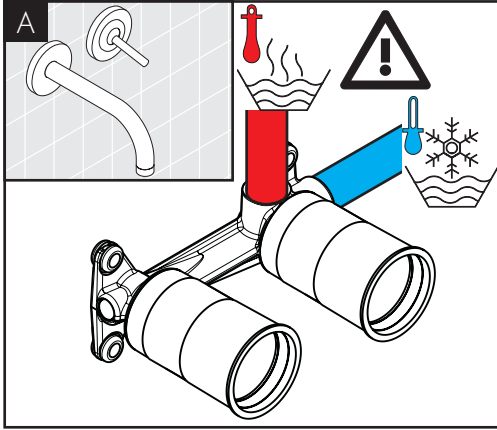



AXOR Bouroullec
19125000/19127000

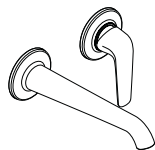

AXOR Citterio M
34112000/34115000

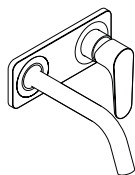

AXOR Citterio M
34113000/34116000

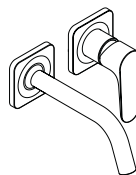

UNO
38112XXX/38115XXX

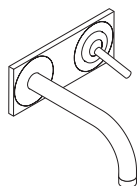

AXOR Uno
38113XXX/38116XXX



AXOR Citterio
39112XXX/39115XXX

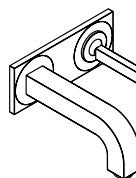

AXOR Citterio
39113XXX/39116XXX

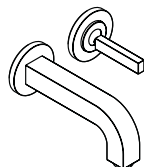

AXOR Citterio E
36106000

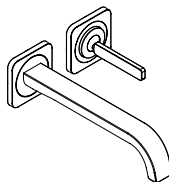

AXOR Citterio E
36114000

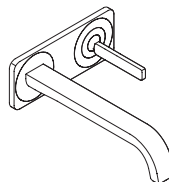

AXOR Uno
38121XXX/38122XXX

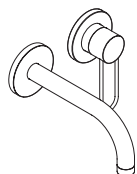

AXOR Uno
45112XXX/45113XXX

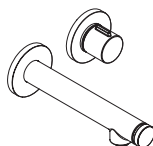

AXOR Uno
38815XXX

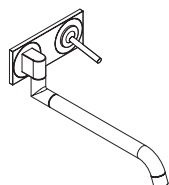



AXOR Bouroullec
19125000

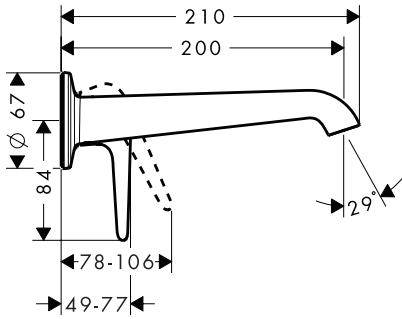

AXOR Bouroullec
19127000

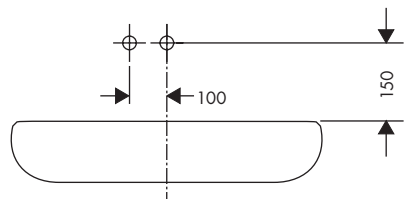
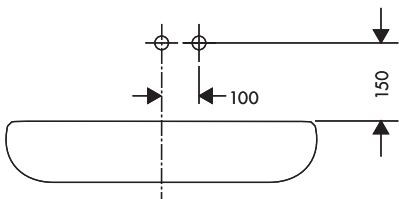
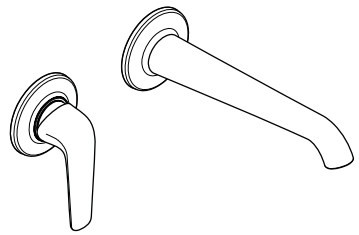
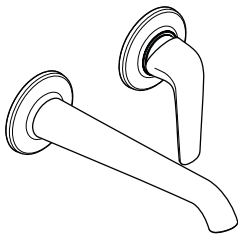
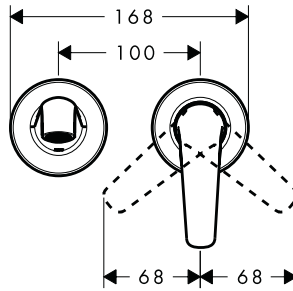
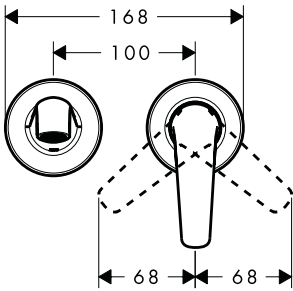
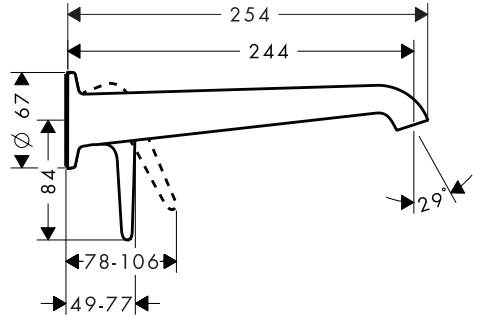



AXOR Citterio M
34112000

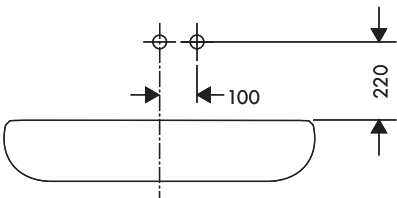
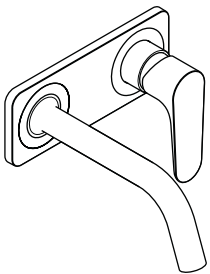
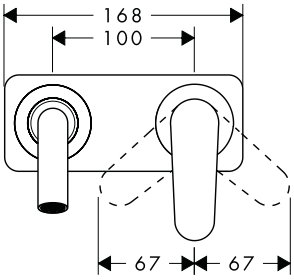
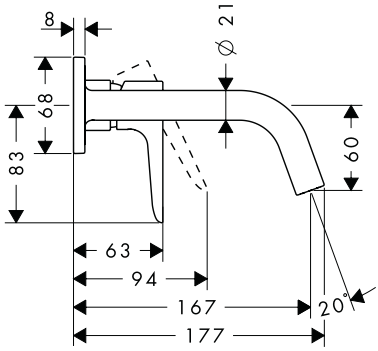

AXOR Citterio M
34115000

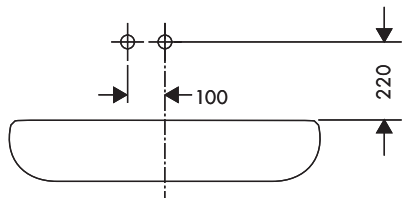
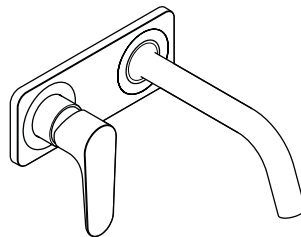
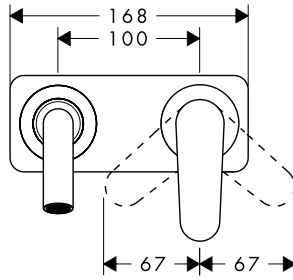
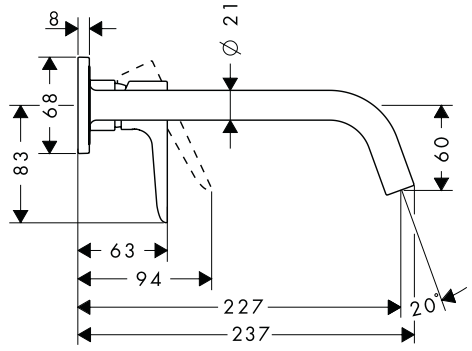



AXOR Citterio M
34113000

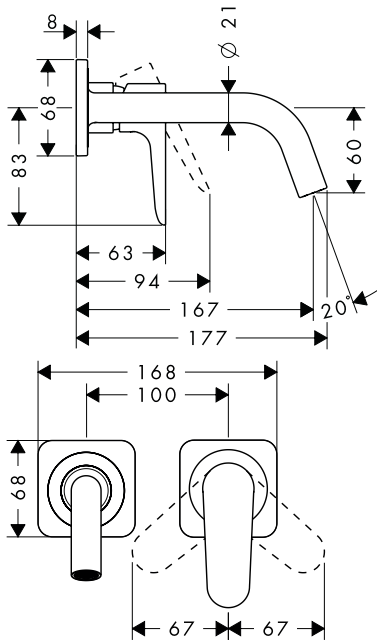

AXOR Citterio M
34116000

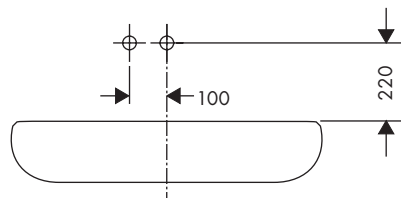
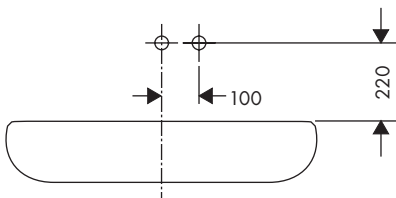
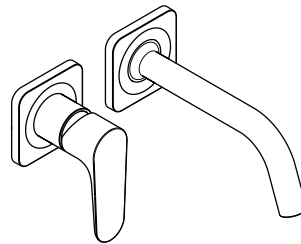
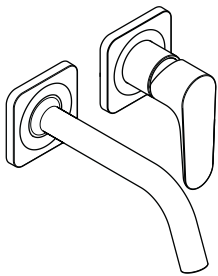
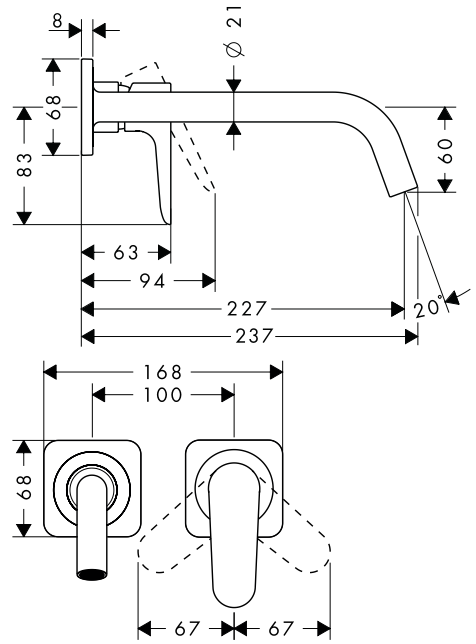



AXOR Uno
38112XXX

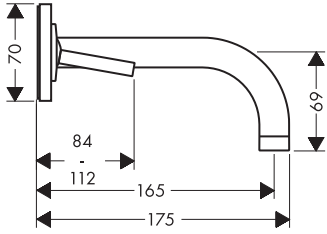

AXOR Uno
38115XXX

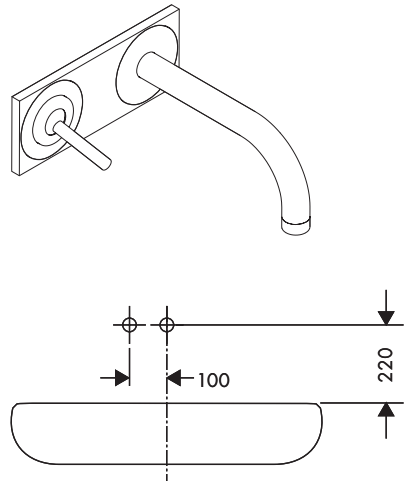
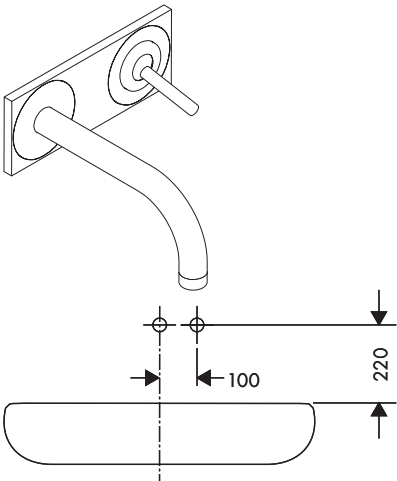
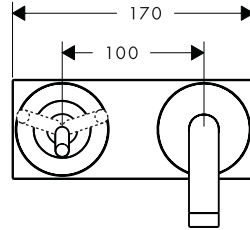
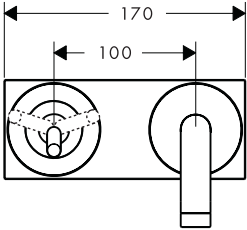
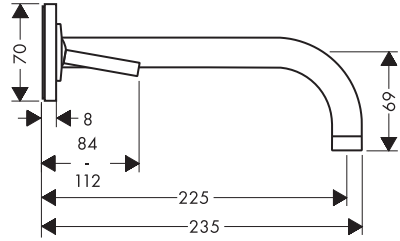



AXOR Uno
38113XXX

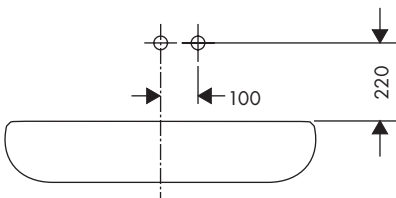
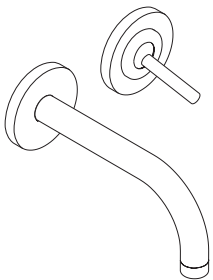
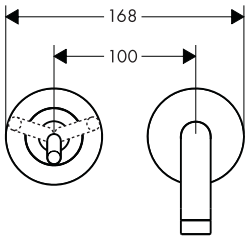
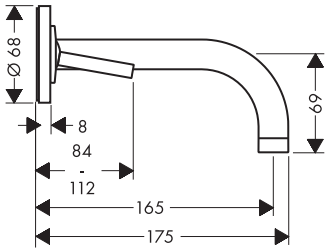

AXOR Uno
38116XXX

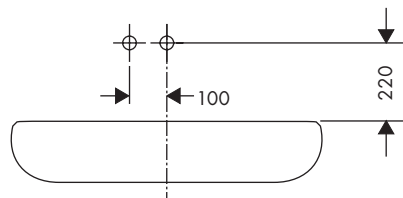
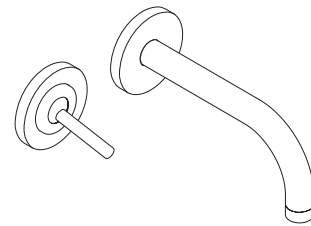
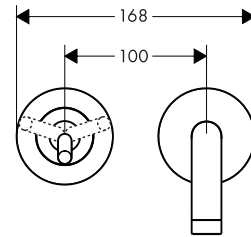
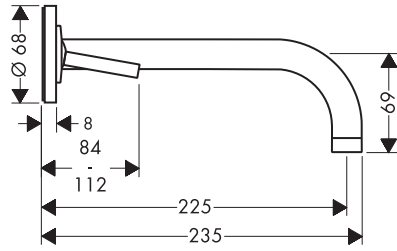



AXOR Citterio
39112XXX

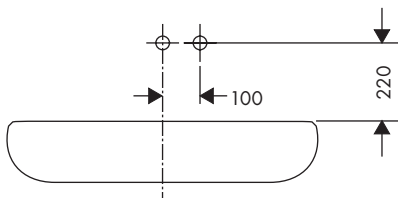
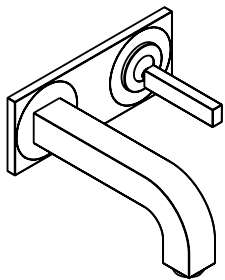
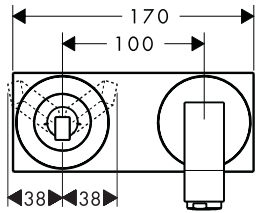
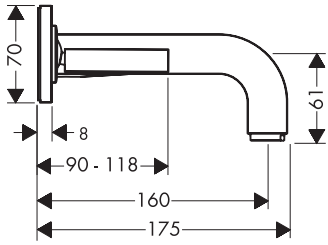

AXOR Citterio
39115XXX

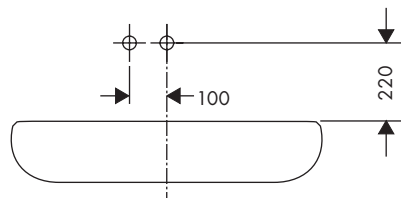
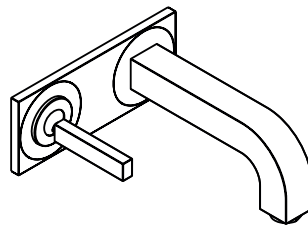
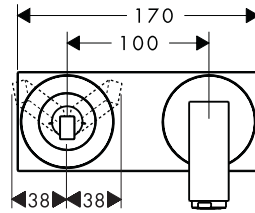
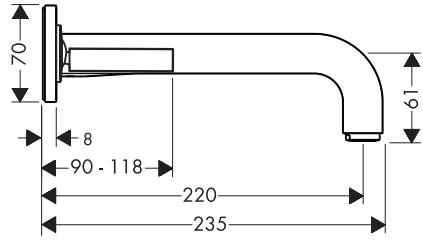



AXOR Citterio
39113XXX

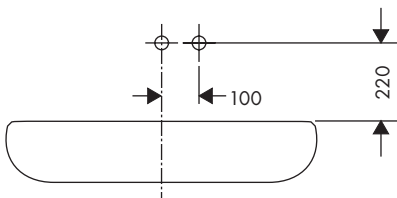
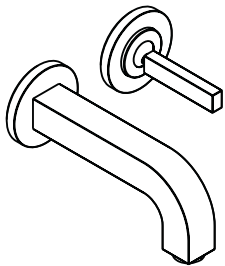
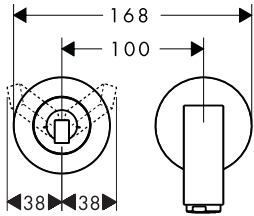
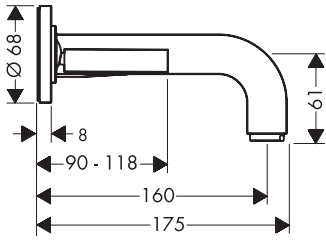

AXOR Citterio
39116XXX

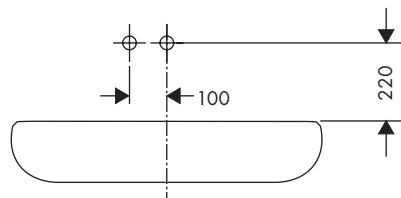
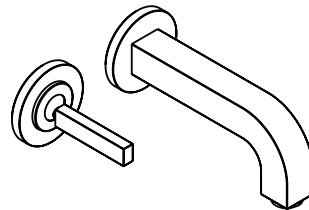
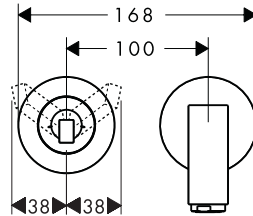
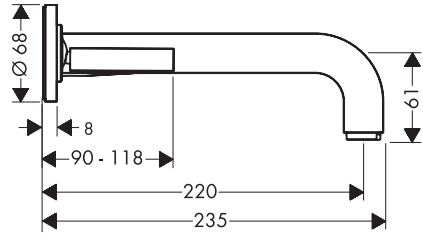



AXOR Citterio E
36106000

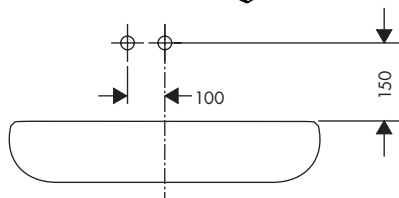
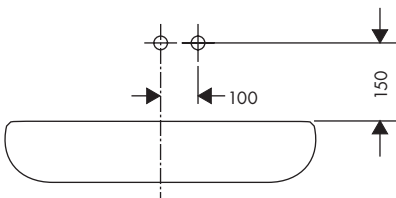
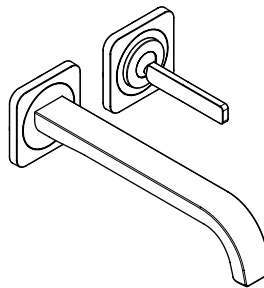
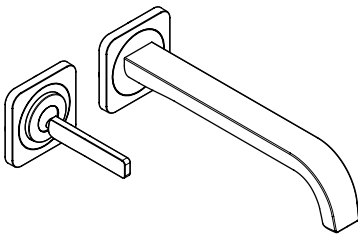
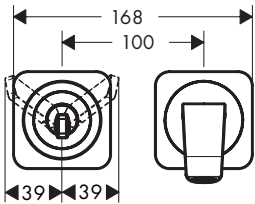
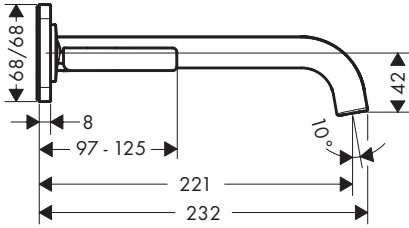



AXOR Citterio E
36114000

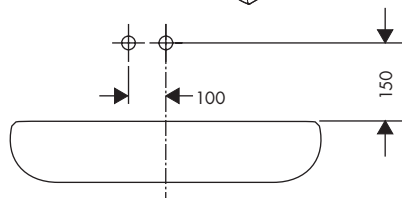
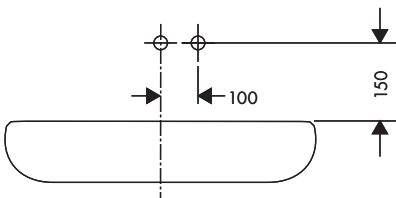
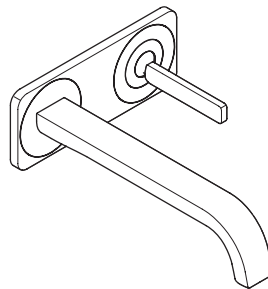
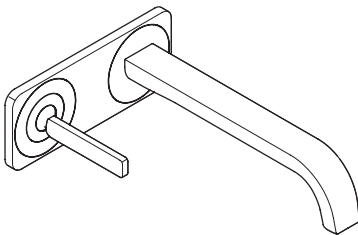
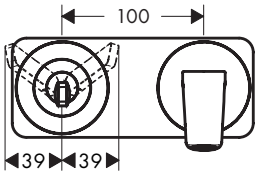
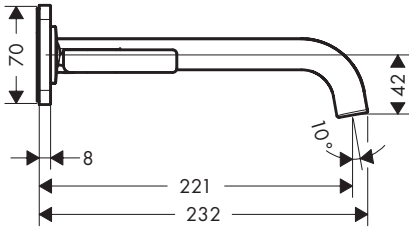



AXOR Uno
38121XXX

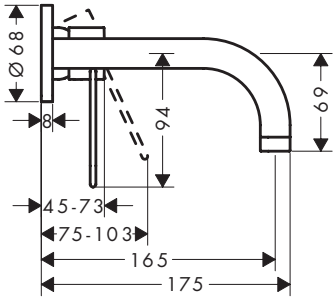

AXOR Uno
38122XXX

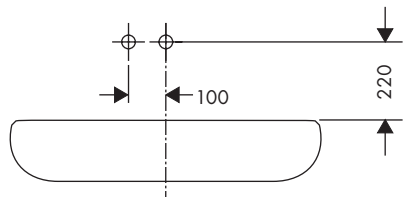
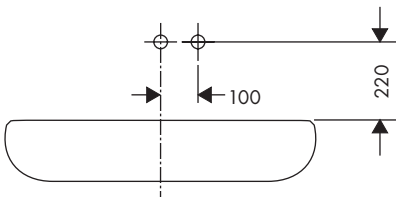
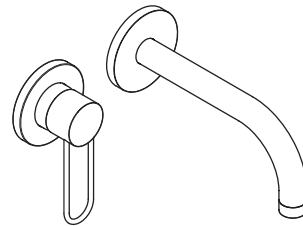
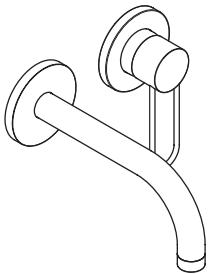
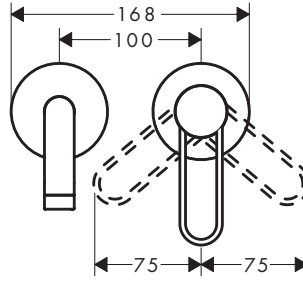
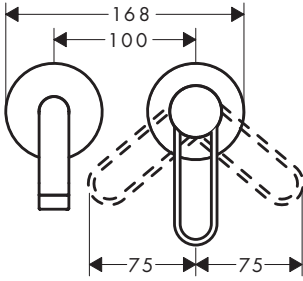
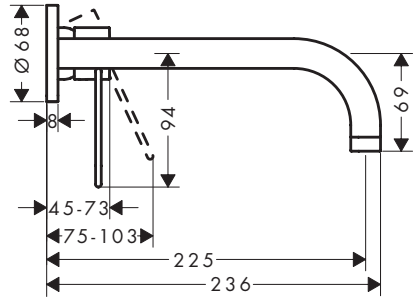



AXOR Uno
45112XXX

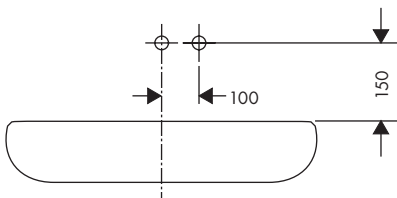
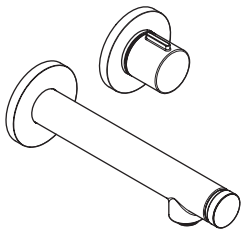
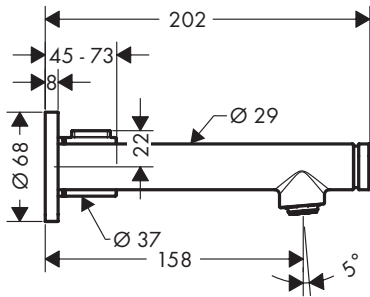
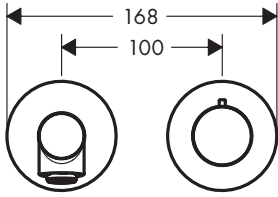

AXOR Uno
45113XXX

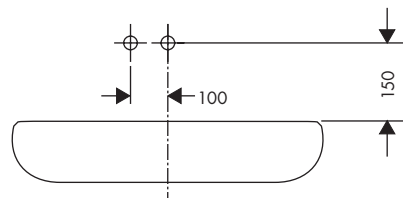
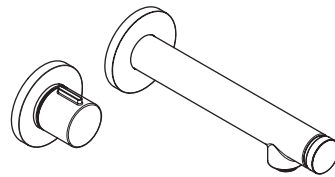
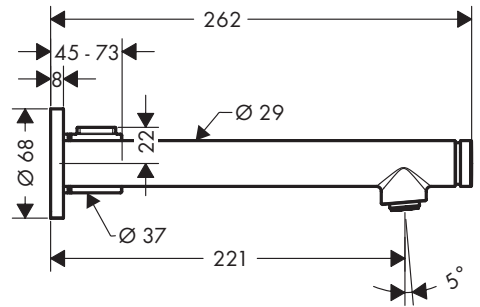
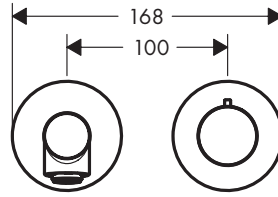



AXOR Uno
38815XXX

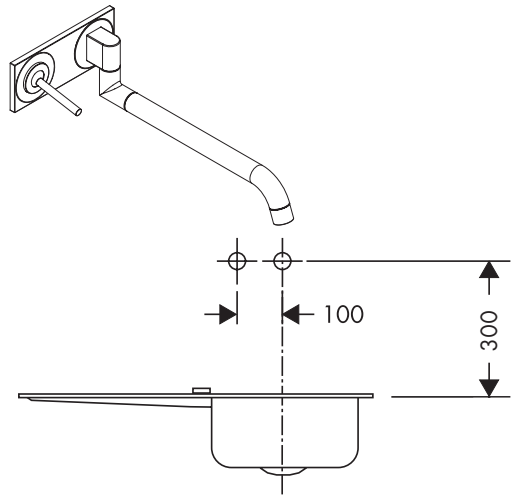
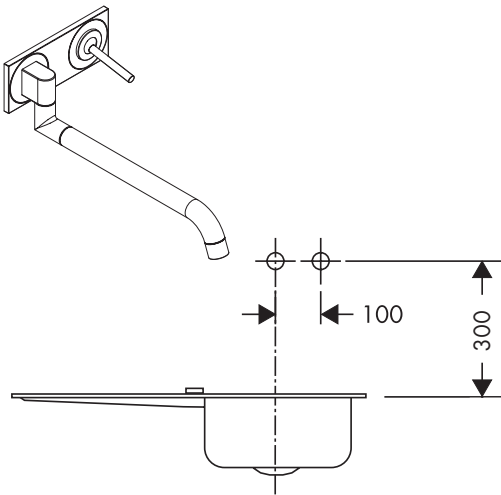
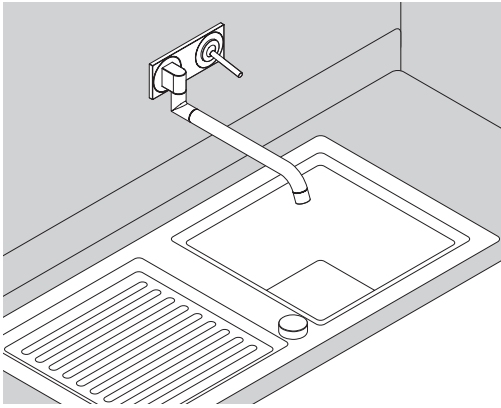
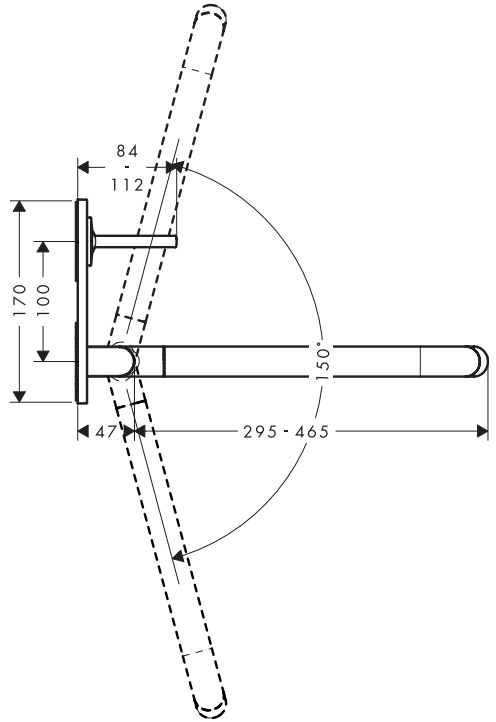
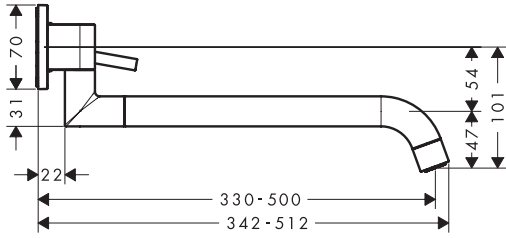

AXOR
13623180

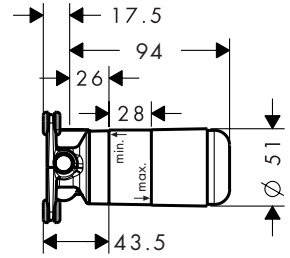
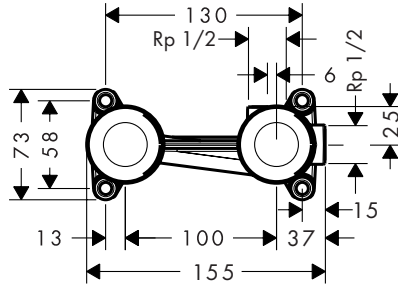

P-IX

ACS

SVGW

WRAS



ETA



GODKENDT
TIL DRILKEVAND

13623180

X

1395

AXOR
13623180

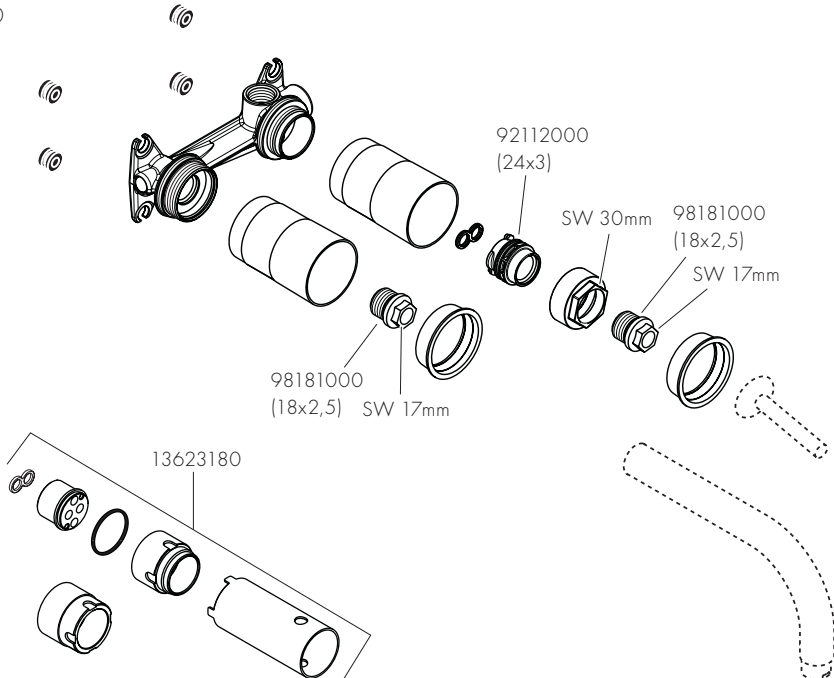

AXOR

AXOR / Hansgrohe SE
Austraße 5-9
77761 Schiltach
Deutschland

info@axor-design.com
axor-design.com

07/2018
911079.01