

Installation

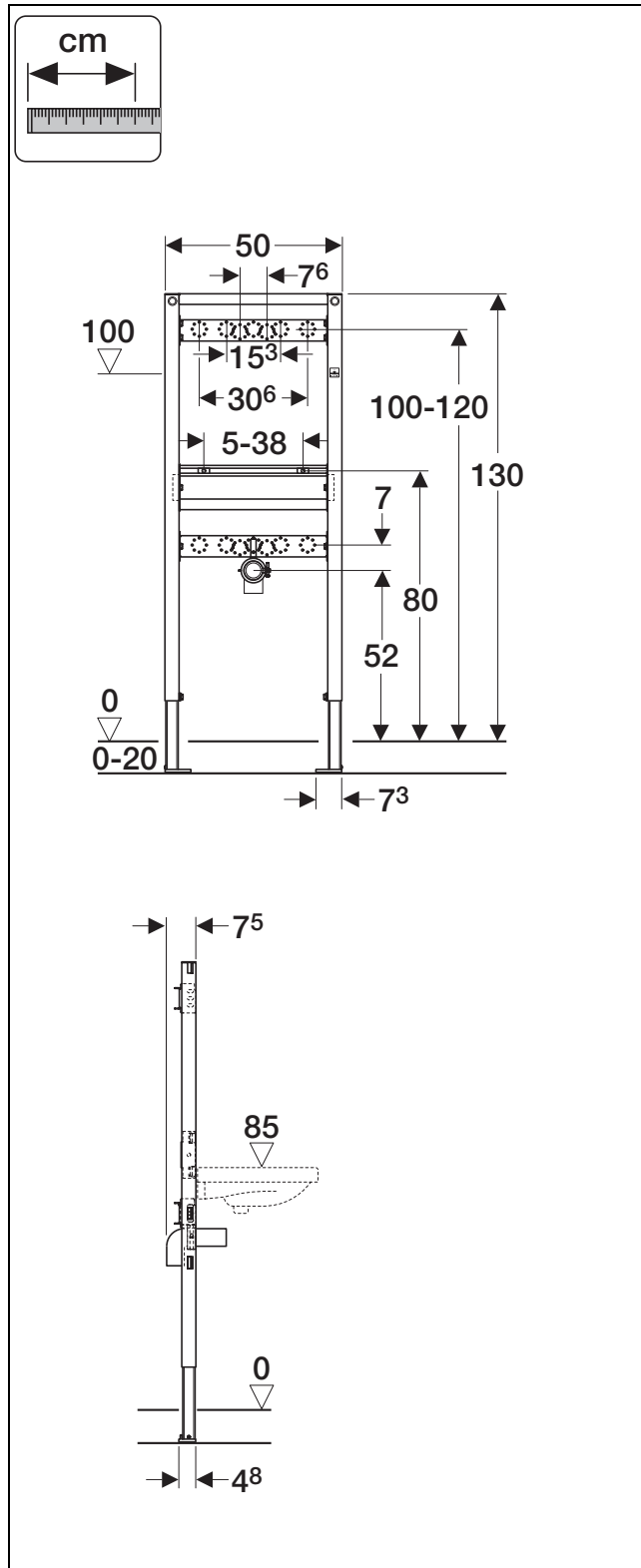

D23921-001&BDC © 01-2008

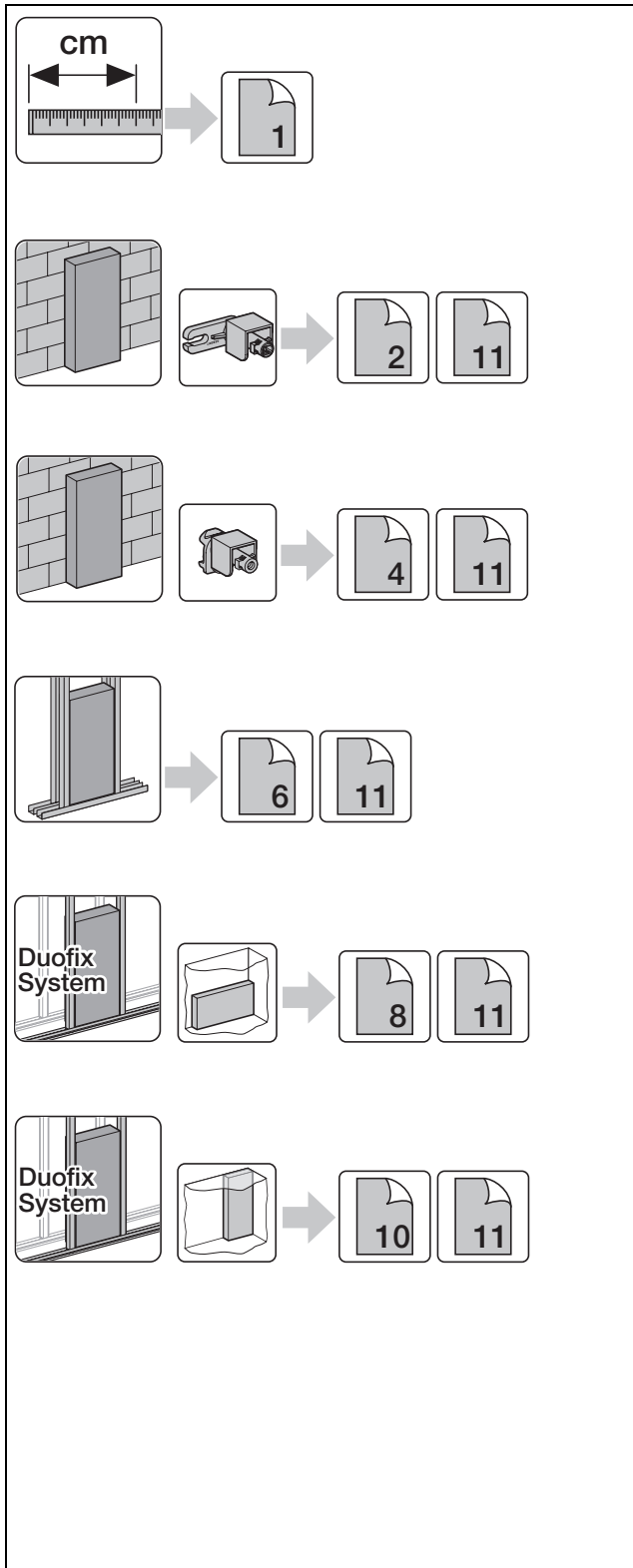

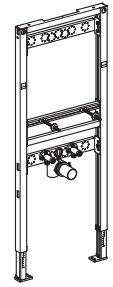
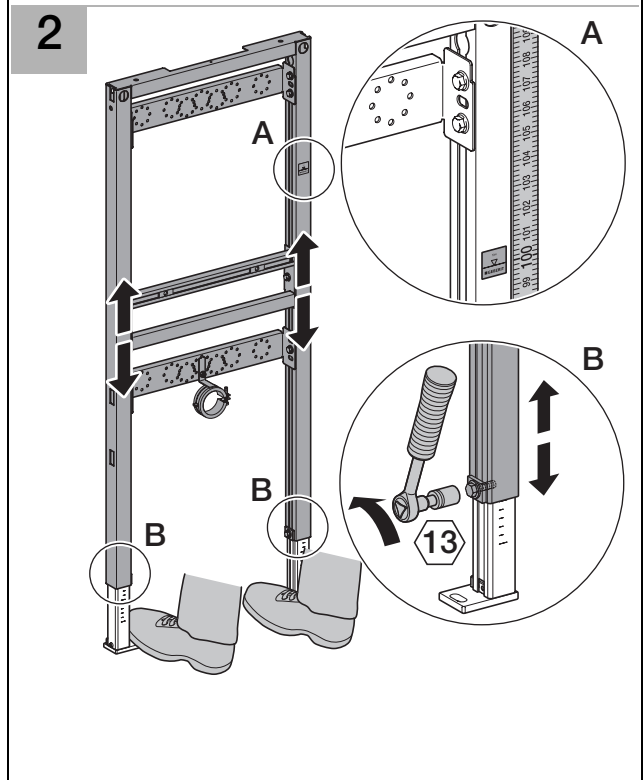
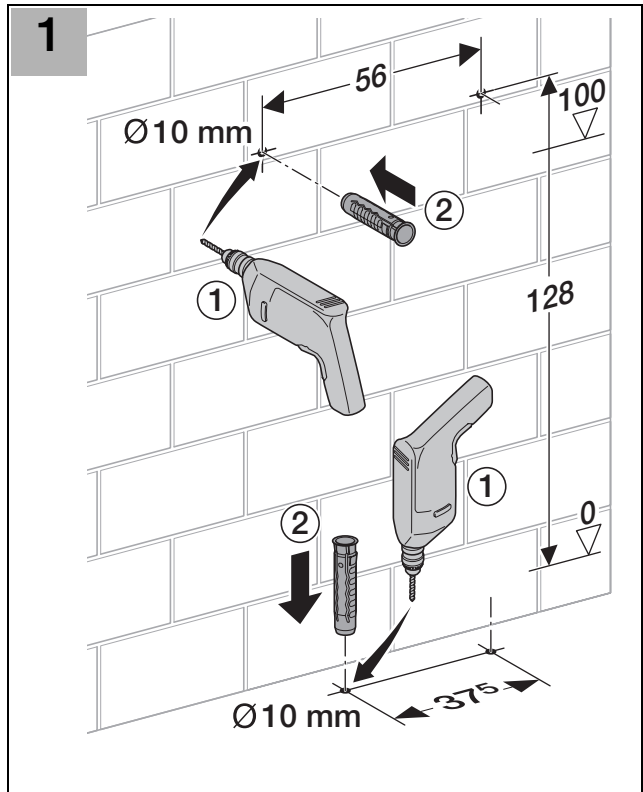
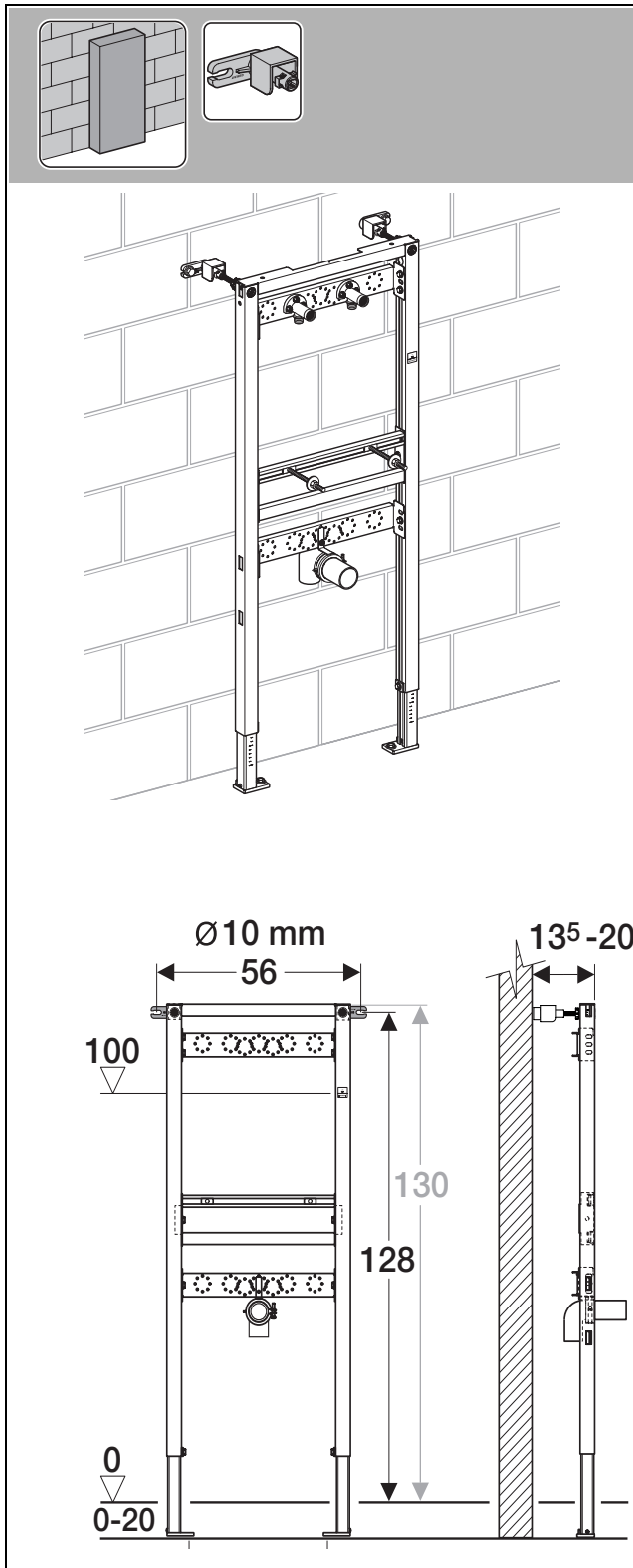
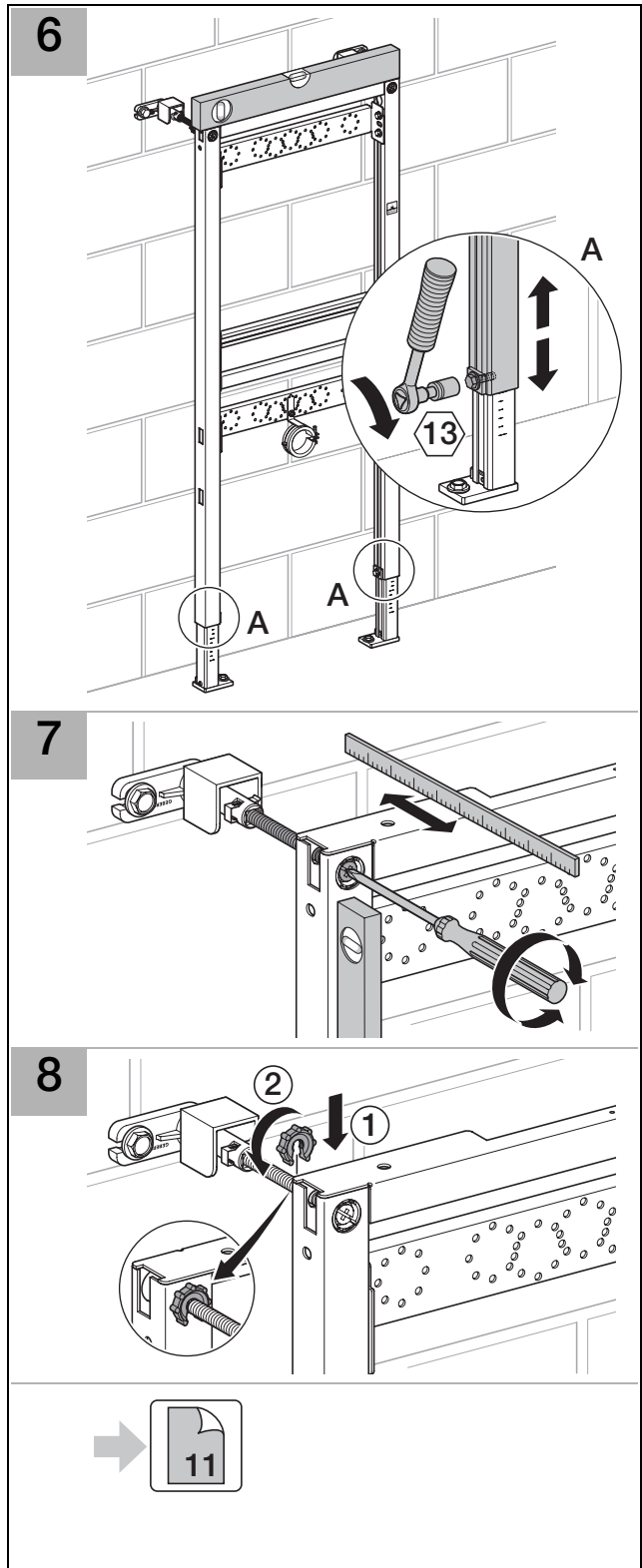
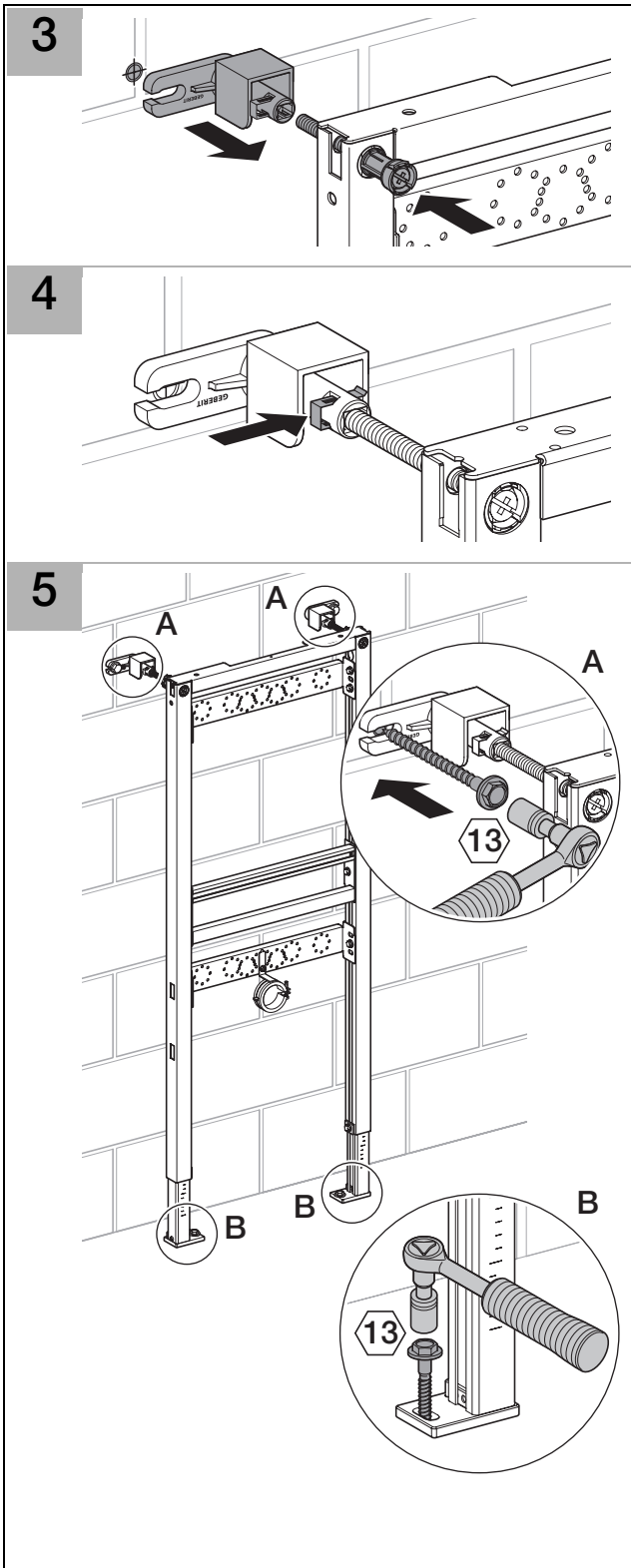

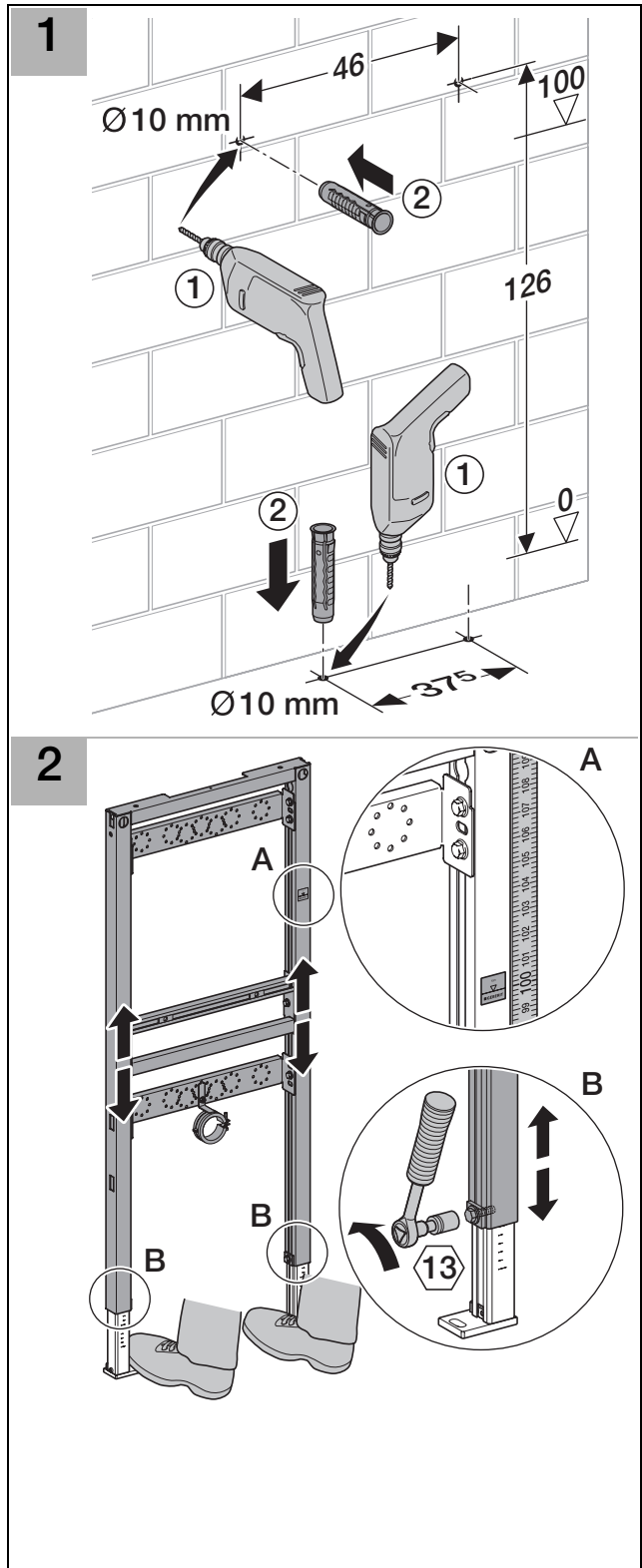
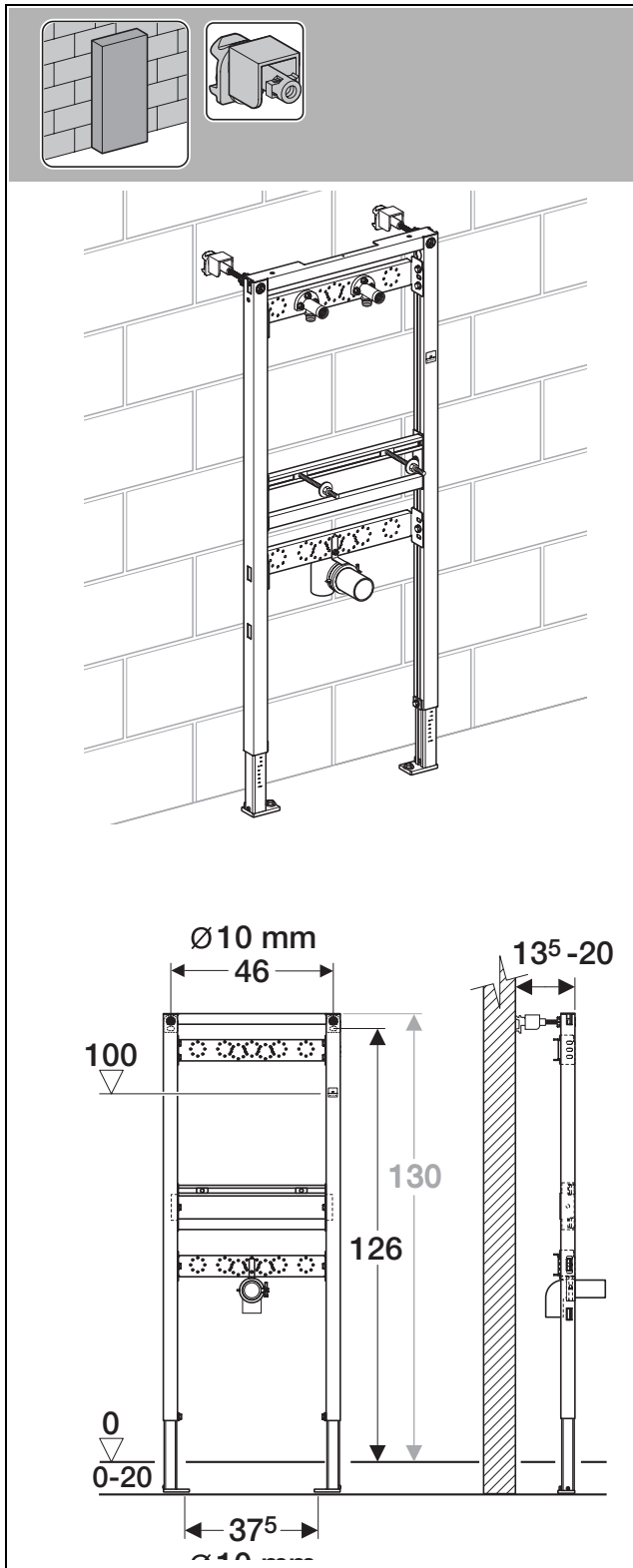

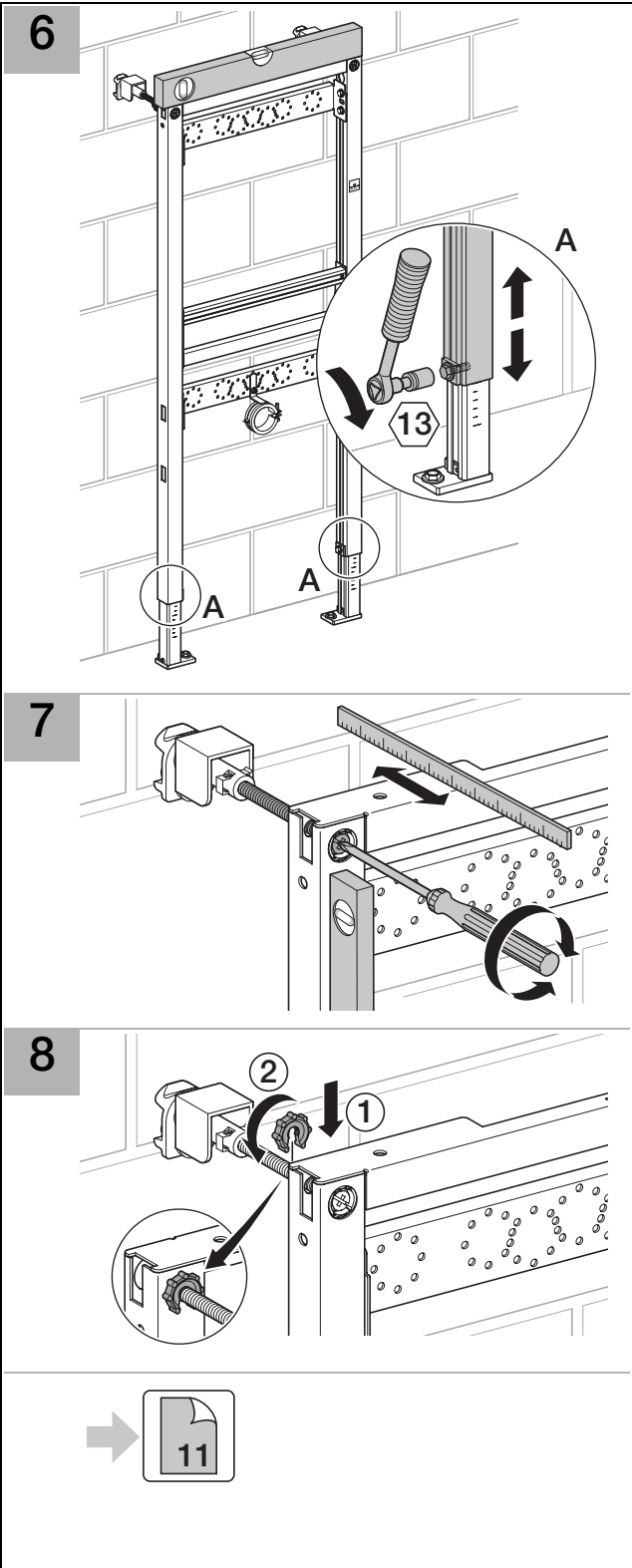
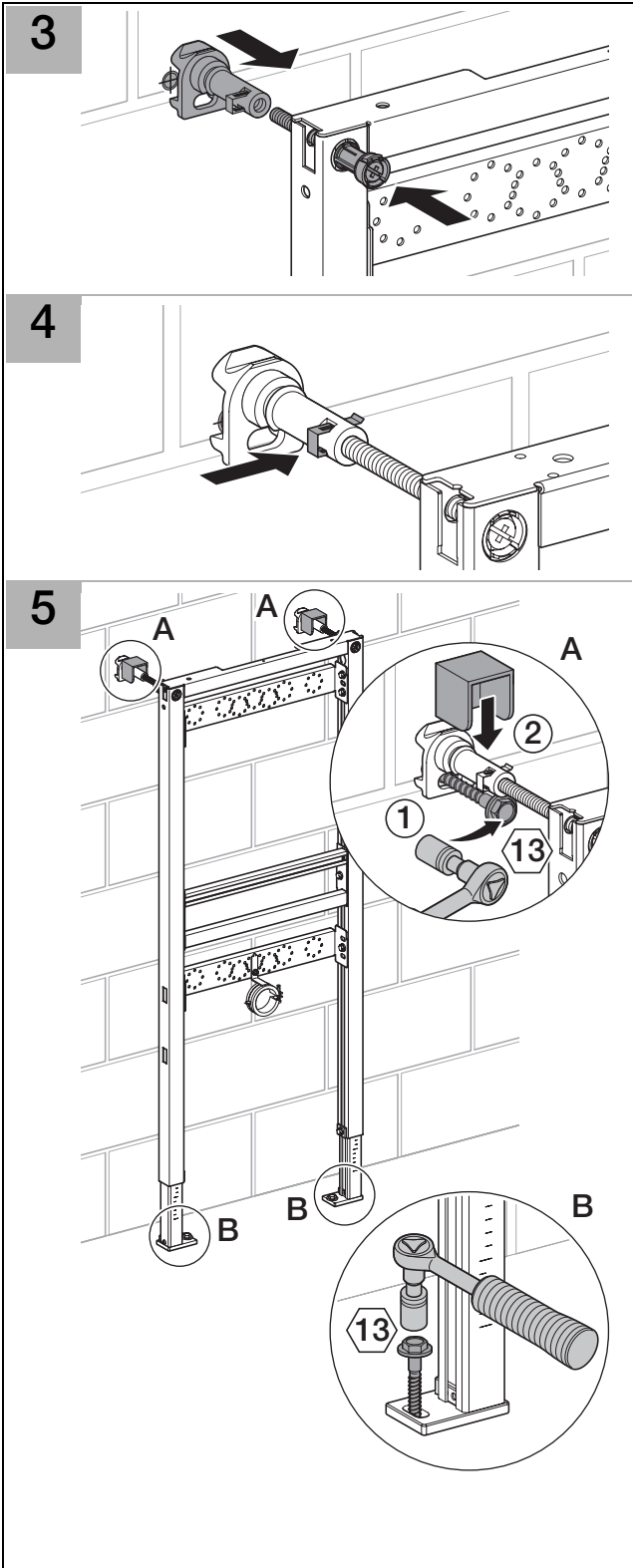

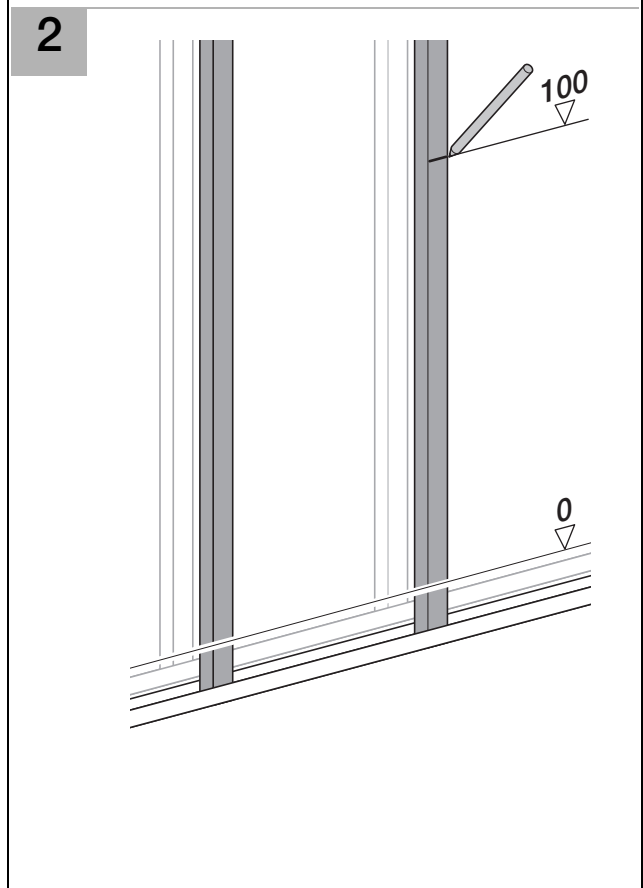
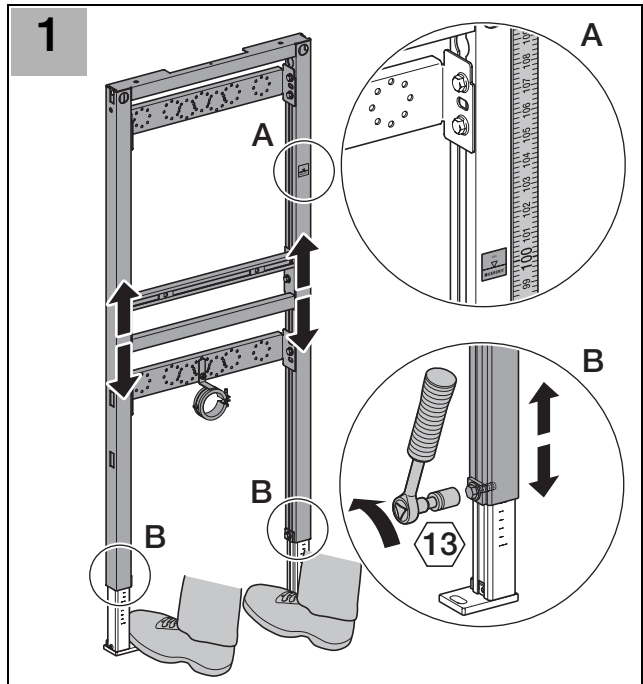
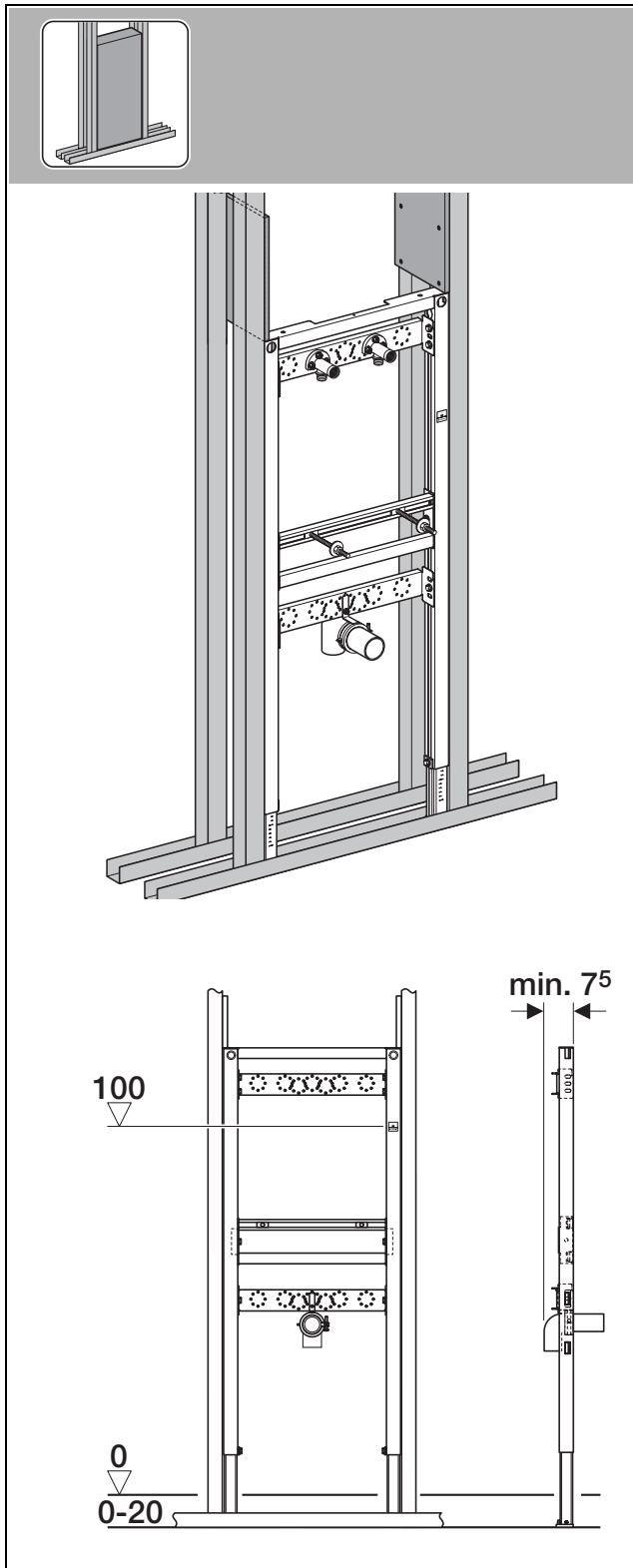

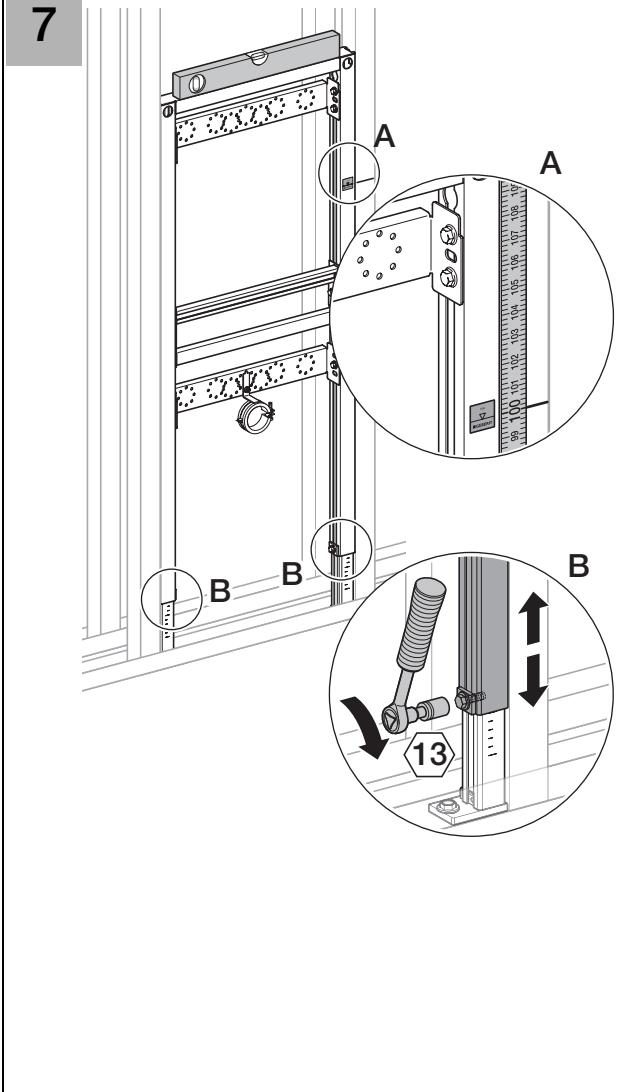
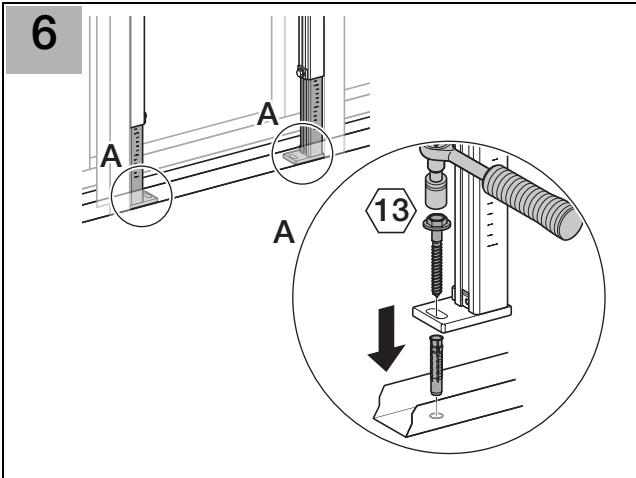
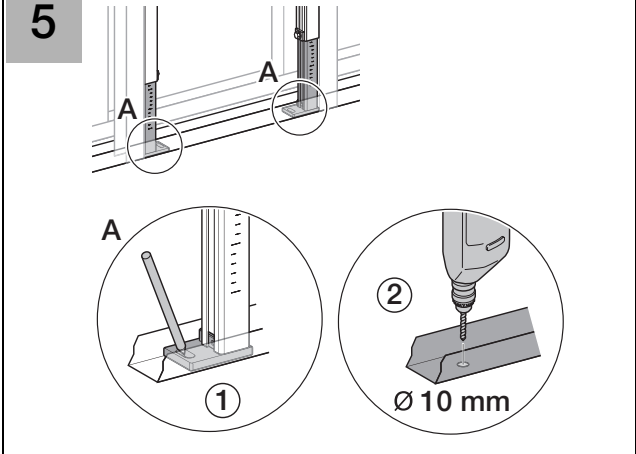
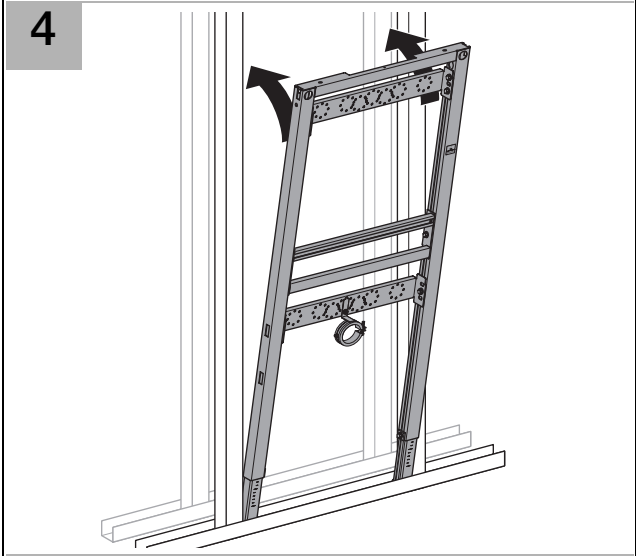
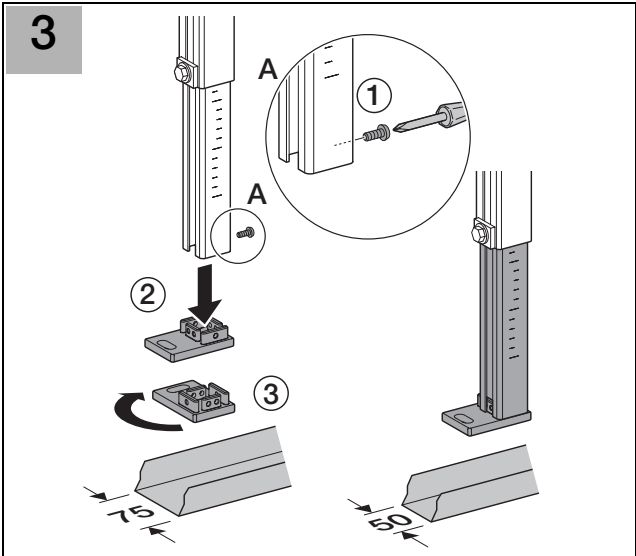

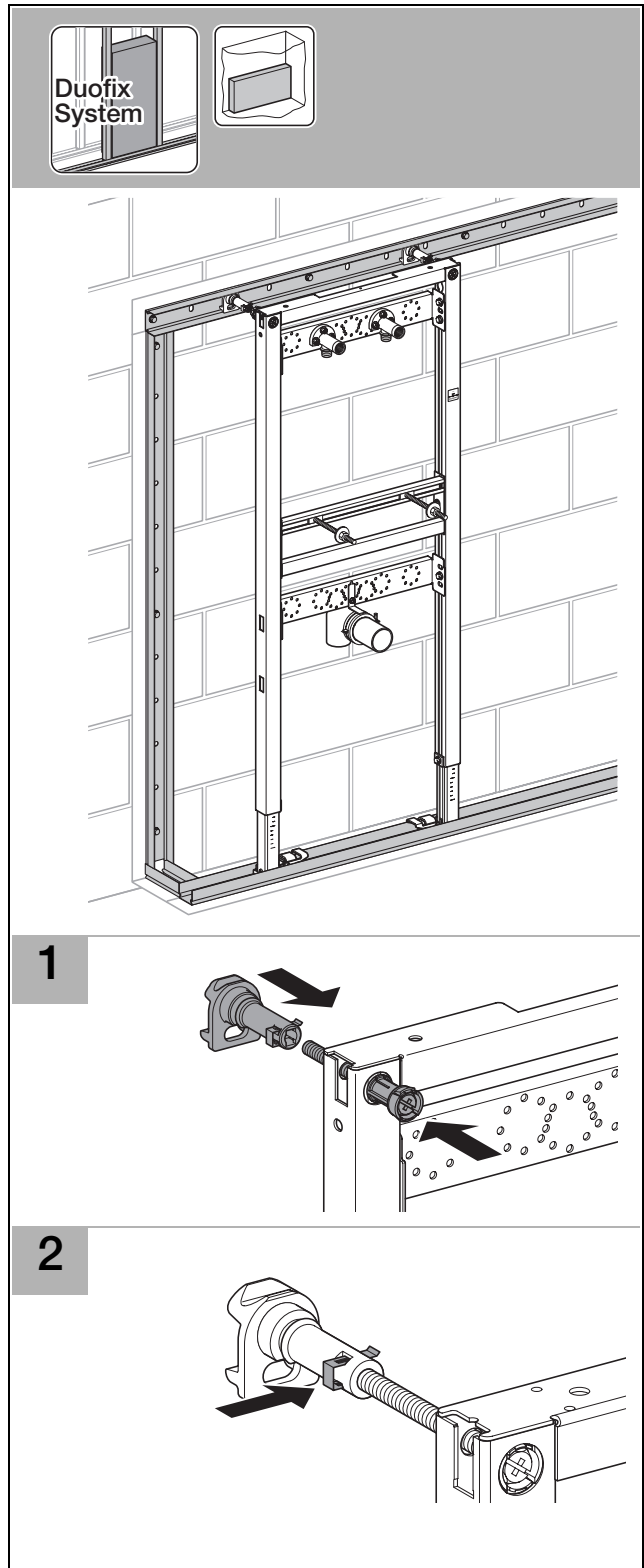
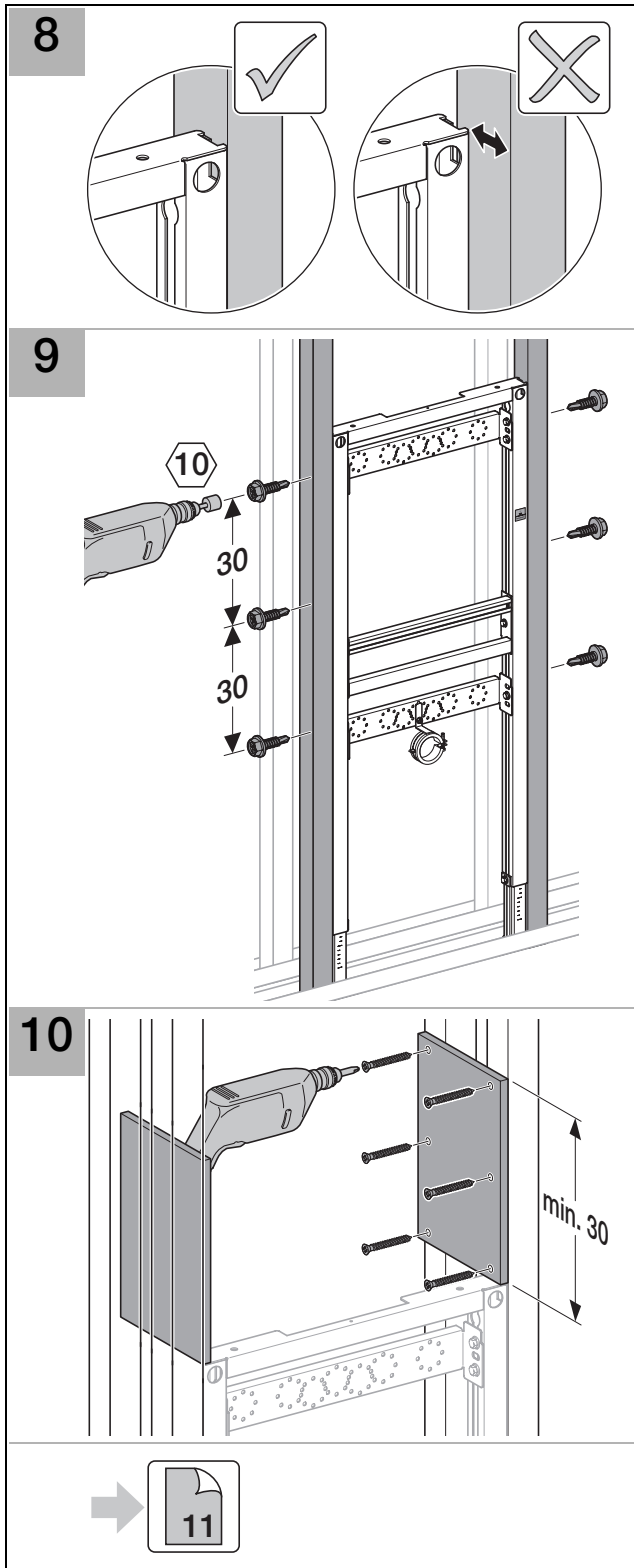

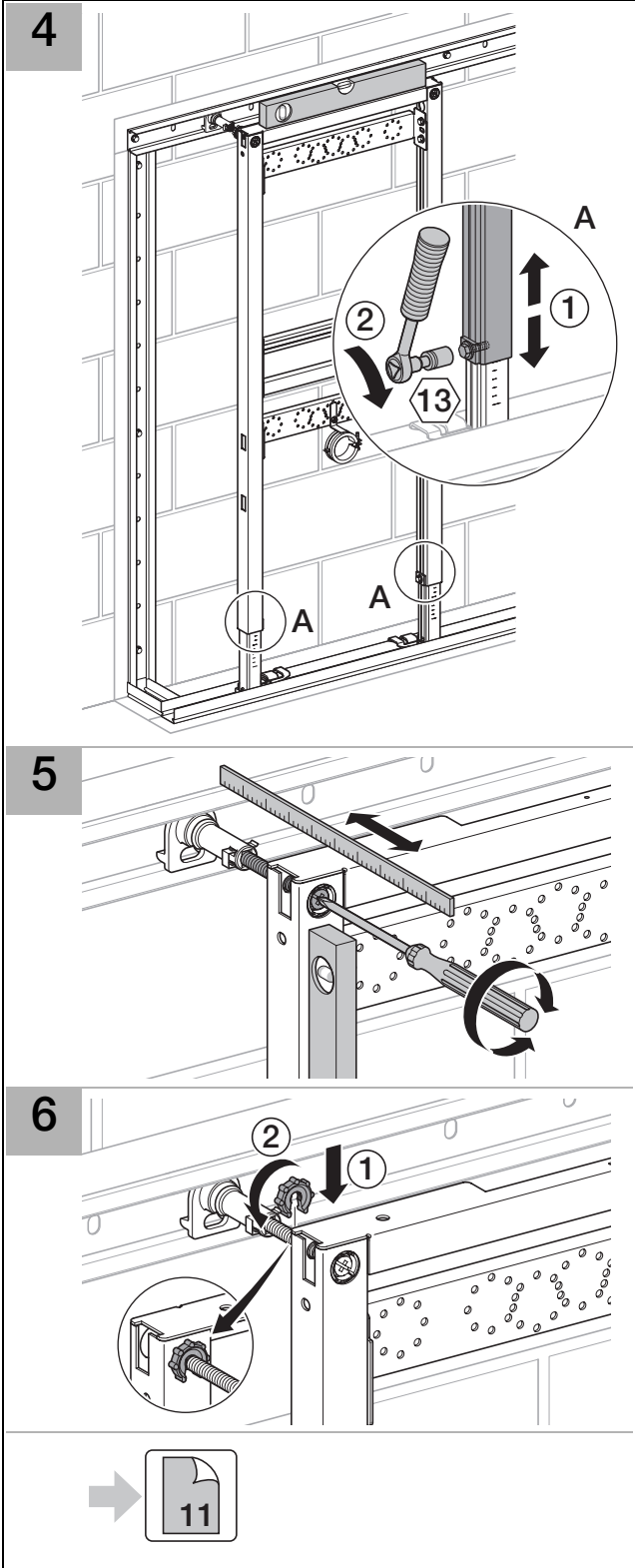
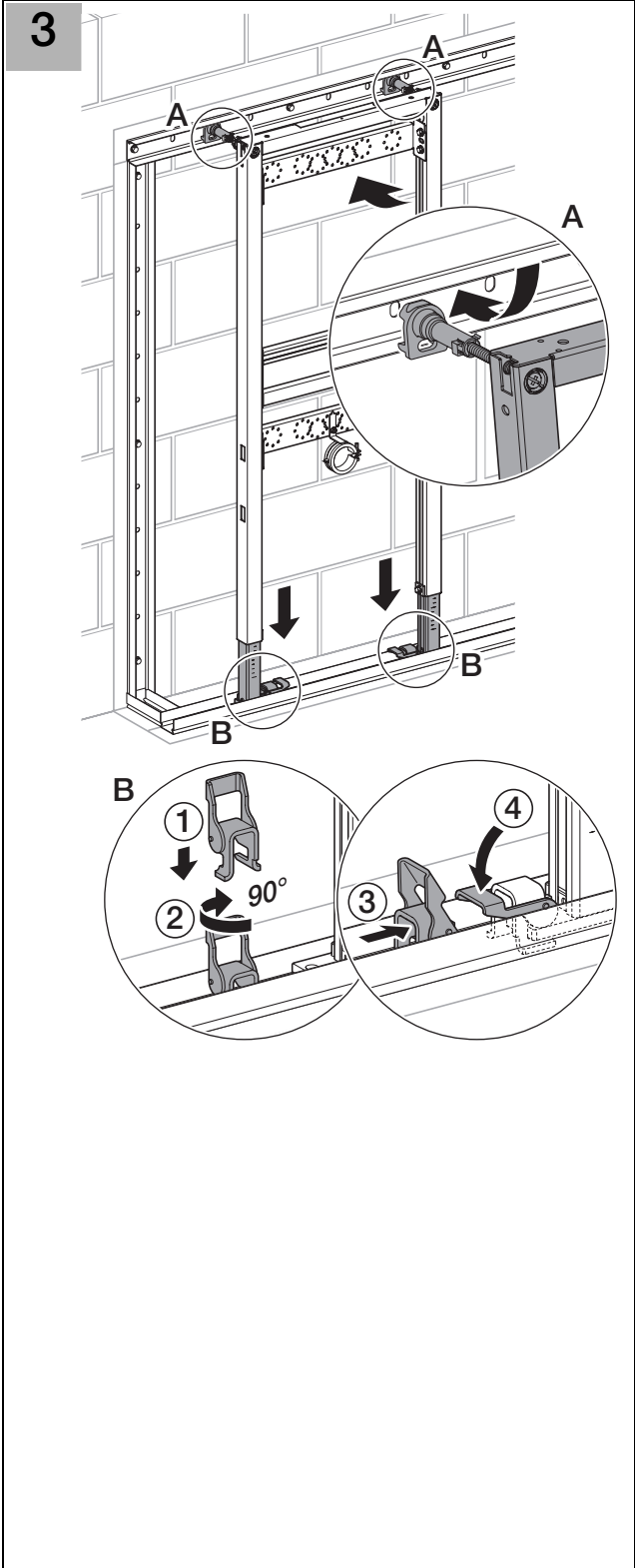

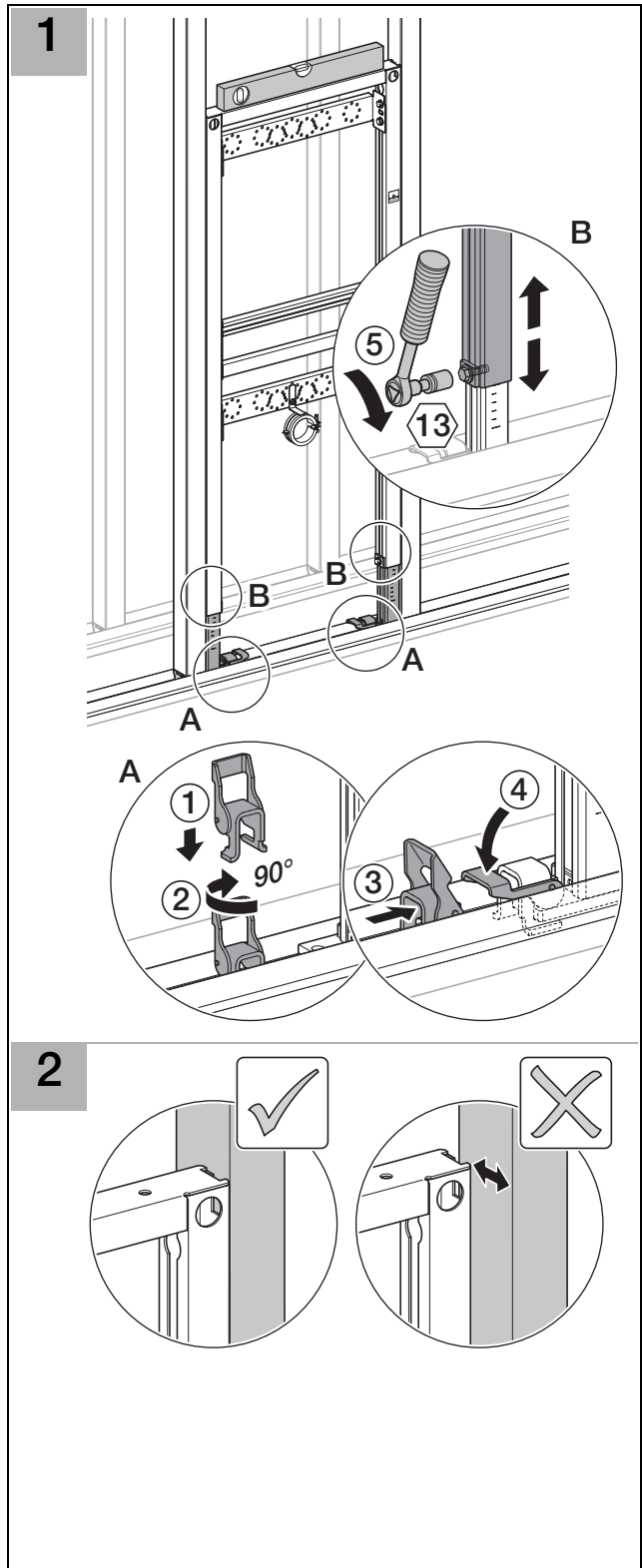
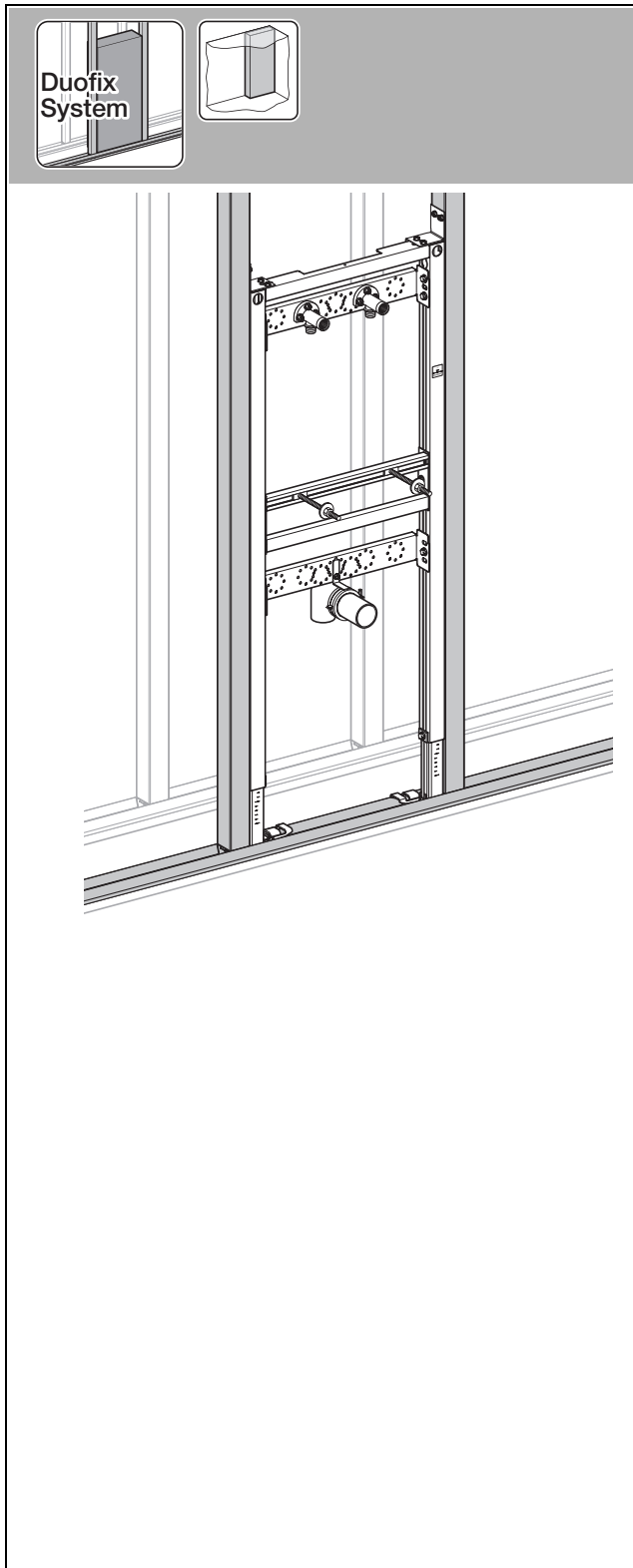

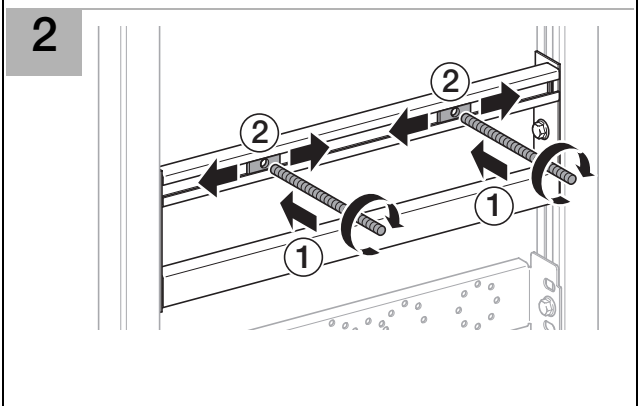
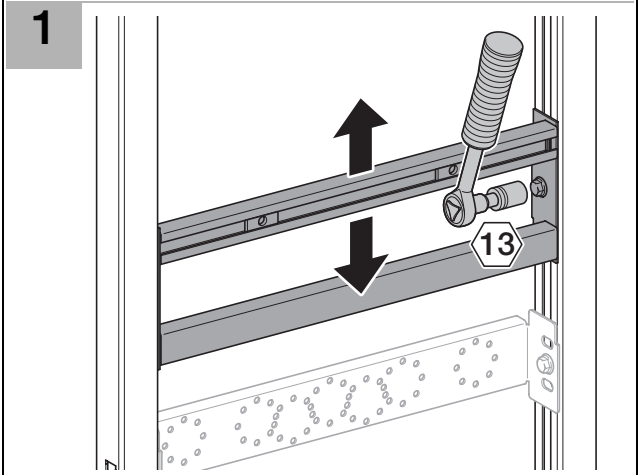
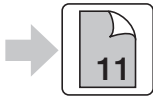
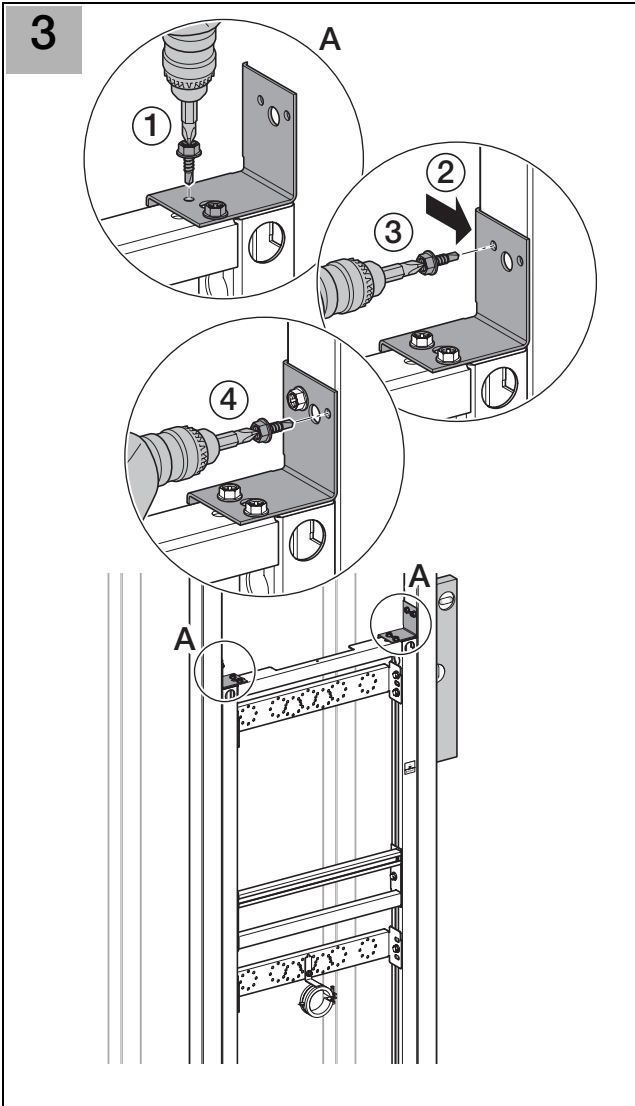

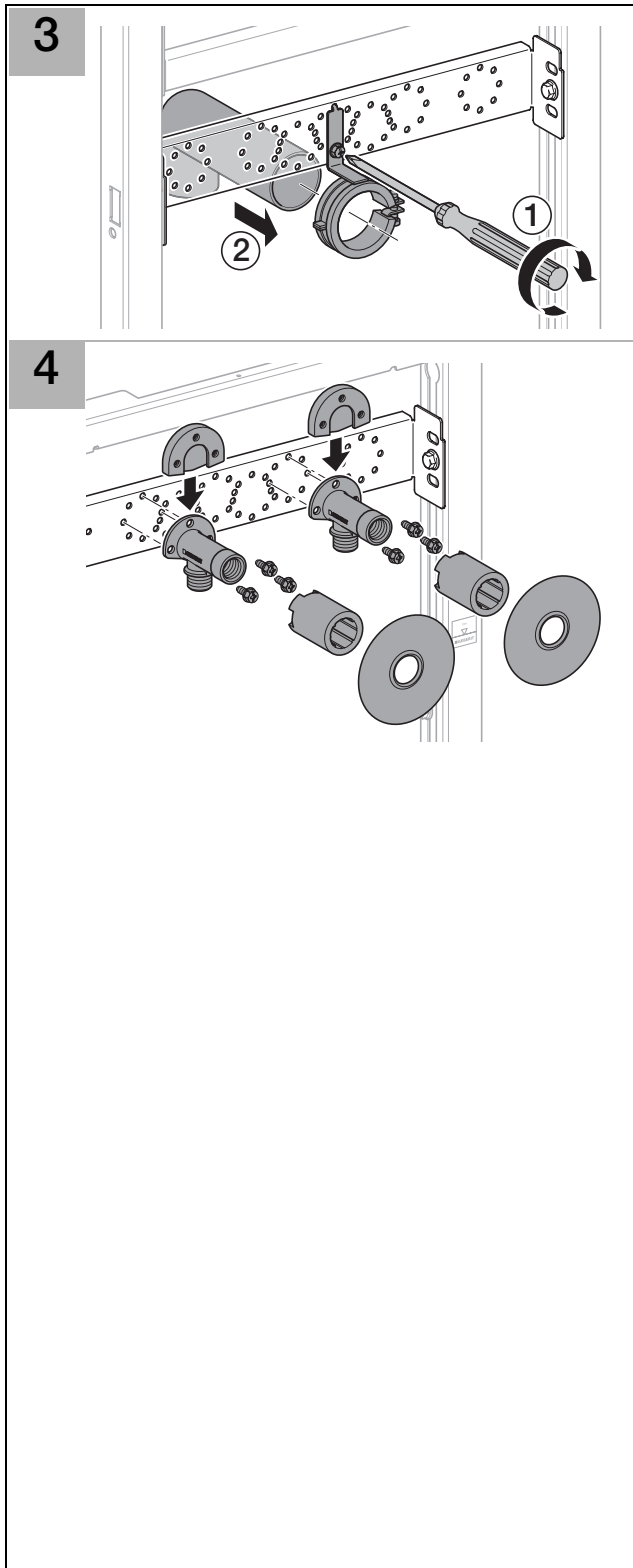

Geberit International AG
Schachenstrasse 77
CH-8645 Jona
www.geberit.com
dokumentation@geberit.com

D23921-001&BDC © 01-2008