

INSTALLATION MANUAL

MONTAGEANLEITUNG
INSTRUCTIONS DE MONTAGE
ISTRUZIONI PER IL MONTAGGIO

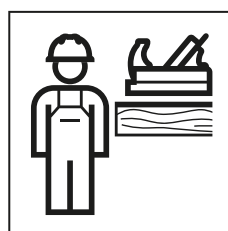

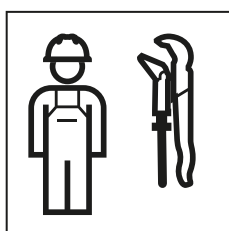

GEFAHR

Unsachgemässe Montage

Herabfallen des Produkts kann zu schweren Verletzungen führen.

- ▶ Vor der Montage die Tragfähigkeit der Wand prüfen.
- ▶ Vor der Montage prüfen, ob das mitgelieferte Befestigungsmaterial für den Wandtyp geeignet ist. Das Befestigungsmaterial bei Bedarf austauschen.



DANGER

Incorrect installation

If the product falls from a height it can lead to serious injuries.

- ▶ Check the bearing capacity of the wall before installation.
- ▶ Before installation, check whether the supplied fastening material is suitable for the type of wall in question. If necessary, replace the fastening material.



DANGER

Montage inapproprié

La chute du produit peut entraîner des blessures graves.

- ▶ Avant le montage, vérifier la portance de la paroi.
- ▶ Avant le montage, vérifier que le matériel de fixation convient au type de paroi. Au besoin, remplacer le matériel de fixation.



PERICOLO

Montaggio inappropriato

La caduta del prodotto può provocare gravi lesioni.

- ▶ Prima del montaggio, verificare la capacità portante della parete.
- ▶ Prima del montaggio, verificare se il materiale di fissaggio fornito in dotazione è adatto per il tipo di parete. All'occorrenza, sostituire il materiale di fissaggio.



GEVAAR

Foutieve montage

Het eraf vallen van het product kan tot ernstig letsel leiden.

- ▶ Vóór de montage het draagvermogen van de wand controleren.
- ▶ Vóór de montage controleren, of het meegeleverde bevestigingsmateriaal voor het wandtype geschikt is. Indien nodig het bevestigingsmateriaal vervangen.



PELIGRO

Montaje inadecuado

La caída del producto puede causar lesiones graves.

- ▶ Antes del montaje, comprobar la capacidad de carga de la pared.
- ▶ Antes del montaje, comprobar si el material de fijación suministrado es el adecuado para el tipo de pared en cuestión. En caso necesario, cambiar el material de fijación.



PERIGO

Montagem incorreta

A queda do produto pode causar ferimentos graves.

- ▶ Verificar a capacidade de carga da parede antes da montagem.
- ▶ Antes da montagem, verificar se o material de fixação fornecido é adequado para o tipo de parede. Se necessário, substituir o material de fixação.



FARE

Forkert montering

Hvis produktet falder ned, kan det føre til alvorlige kvæstelser.

- ▶ Kontroller væggens bæredygtighed inden monteringen.
- ▶ Kontroller inden monteringen, at det medfølgende fastgørelsesmateriale er egnet til vægtypen. Udskift fastgørelsesmaterialet ved behov.



FARE

Feil montering

Hvis produktet faller ned, kan det føre til alvorlige personskader.

- ▶ Kontroller bæreevnen til veggen før montering.
- ▶ Kontroller før montering om det medfølgende festematerialet egner seg for veggtypen. Bytt ut festematerialet ved behov.



FARA

Felaktig montering

Nedfallande produkt kan leda till allvarliga personskador.

- ▶ Kontrollera väggens hållfasthet före montering.
- ▶ Kontrollera före montering om det medföljande infästningsmaterialet är lämpat för vaggtypen. Byt vid behov ut infästningsmaterialet.



VAARA

Epäsianmukainen asennus

Tuotteen putoamisesta voi aiheutua vakavia loukkaantumisia.

- ▶ Tarkasta seinän kantavuus ennen asentamista.
- ▶ Tarkasta ennen asentamista, sopiiko toimitettu kiinnitysmateriaali seinän tyyppiin. Vaihda kiinnitysmateriaali tarvittaessa.



HÆTTA

Ekki farið rétt að við uppsetningu

Ef varan fellur niður getur það valdið alvarlegum meiðslum.

- ▶ Kanna skal burðargetu veggs áður en uppsetning fer fram.
- ▶ Ganga skal úr skugga um að meðfylgjandi festibúnaður henti fyrir vegginn áður en uppsetning fer fram. Ef þörf krefur skal nota annan festibúnað.



NIEBEZPIECZEŃSTWO

Nieprawidłowy montaż

Spadnięcie produktu może prowadzić do ciężkich obrażeń.

- ▶ Przed montażem sprawdzić nośność ściany.
- ▶ Przed montażem sprawdzić, czy dostarczone elementy mocujące są przeznaczone do danego typu ściany. W razie potrzeby wymienić elementy mocujące.



VESZÉLY

Szakszerűtlen szerelés

A termék leesése súlyos sérüléseket okozhat.

- ▶ Felszerelés előtt ellenőrizze a fal tartóképességét.
- ▶ Felszerelés előtt ellenőrizze, hogy a mellékelt rögzítési anyag alkalmas-e az adott faltípushoz. Szükség esetén cserélje ki a rögzítési anyagot.



NEBEZPEČENSTVO

Neodborná montáž

Spadnutie výrobku môže viesť k ťažkým zraneniam.

- ▶ Pred montážou skontrolujte nosnosť steny.
- ▶ Pred montážou skontrolujte, či dodaný pripevňovací materiál je vhodný pre príslušný typ steny. V prípade potreby vymeňte pripevňovací materiál.



NEBEZPEČÍ

Neodborná montáž

Pád výrobku môže spôsobiť ťžké úrazy.

- ▶ Před montáží zkontrolujte nosnost stěny.
- ▶ Před montáží zkontrolujte, zda je dodaný upevňovací materiál vhodný pro daný typ stěny. V případě potřeby upevňovací materiál vyměňte.



NEVARNOST

Nestrokovna montaža

Padec izdelka lahko povzroči težke poškodbe.

- ▶ Pred montažo preverite nosilnost stene.
- ▶ Pred montažo preverite, ali je dobavljene pritržilni material primeren za tip stene. Pritrdilni material po potrebi zamenajte.



OPASNOST

Nestručna montaža

Pad proizvoda može izazvati teške ozljede.

- ▶ Prije montaže provjerite nosivost zida.
- ▶ Prije montaže provjerite je li isporučeni pričvršni materijal prikladan za tip zida. Po potrebi zamijenite pričvršni materijal.



OPASNOST

Nepravilna montaža

Padanje proizvoda može da dovede do teških povreda.

- ▶ Pre montaže ispitati nosivost zida.
- ▶ Pre montaže ispitati da li je isporučeni materijal za pričvršćenje pogodan za tip zida. Materijal za pričvršćenje, po potrebi, zameniti.



OHT

Asjatundmatu paigaldus

Toote allakukkumine võib põhjustada raskeid vigastusi.

- ▶ Enne paigaldamist kontrollige seina kande võimet.
- ▶ Enne paigaldamist kontrollige, kas kaasapandud kinnitusmaterjal sobib seina tüübiga. Vajadusel asendage kinnitusmaterjal.



BĪSTAMI

Nelietpratīga montāža

Produkta nokrišana var izraisīt smagus traumas.

- ▶ Pirms montāžas pārbaudiet sienas nestspēju.
- ▶ Pirms montāžas pārbaudiet, vai piegādes komplektā iekļautais stiprinājuma materiāls ir piemērots sienas tipam. Stiprinājuma materiālu nepieciešamības gadījumā nomainiet.



PAVOJINGA

Netinkamas montavimas

Nukritęs gaminys gali sukelti sunkius kūno sužalojimus.

- ▶ Prieš montavimą patikrinkite sienos atsparumą apkrovai.
- ▶ Prieš montavimą patikrinkite, ar patiekta tvirtinimo medžiaga pritaikyta sienos tipui. Jeigu būtina, tvirtinimo medžiagą pakeiskite.



ОПАСНОСТ

Неправилен монтаж

Падането на продукта може да причини тежки наранявания.

- ▶ Преди монтажа проверете товароносимостта на стената.
- ▶ Преди монтажа проверете дали доставените с продукта крепежни елементи са подходящи за типа стена. При необходимост сменете крепежните елементи.



PERICOL

Montaj incorect

Căderea produsului se poate solda cu leziuni grave.

- ▶ Înaintea montajului, verificați capacitatea portantă a peretelui.
- ▶ Înaintea montajului, verificați dacă materialul de fixare livrat este adecvat pentru tipul de perete respectiv. La nevoie, înlocuiți materialul de fixare.



ΚΙΝΔΥΝΟΣ

Λανθασμένη συναρμολόγηση

Η πτώση του προϊόντος μπορεί να οδηγήσει σε σοβαρούς τραυματισμούς.

- ▶ Πριν από τη συναρμολόγηση, ελέγξτε τη φέρουσα ικανότητα του τοίχου.
- ▶ Πριν από τη συναρμολόγηση, ελέγξτε αν το παρεχόμενο υλικό στερέωσης είναι κατάλληλο για τον συγκεκριμένο τύπο τοίχου. Εάν χρειάζεται, αντικαταστήστε το υλικό στερέωσης.



TEHLİKE

Hatalı montaj

Ürünün düşmesi ağır yaralanmalara yol açabilir.

- ▶ Montajdan önce duvarın taşıma kapasitesini kontrol edin.
- ▶ Montajdan önce, birlikte teslim edilen sabitleme malzemesinin duvar tipi için uygun olup olmadığını kontrol edin. Gerekirse sabitleme malzemesini değiştirin.



ОПАСНО

Неквалифицированный монтаж

Падение изделия может привести к получению тяжелых травм.

- ▶ Перед монтажом проверить несущую способность стены.
- ▶ Перед монтажом проверить, подходят ли входящие в комплект поставки крепежи к типу стены. При необходимости заменить крепежи.



危险

安装不当

产品坠落可能造成人员重伤。

- ▶ 安装前检查墙壁的承载能力。
- ▶ 安装前检查随附的紧固件是否适用于此类墙壁。必要时更换紧固件。



خطر

التركيب غير السليم

قد يؤدي سقوط المنتج إلى إصابات بالغة.

- ▶ تحقق من القدرة التحميلية للجدار قبل التركيب.
- ▶ تأكد قبل التركيب من أن مادة التثبيت المرفقة مناسبة لنوع الجدار. قم بتغيير مادة التثبيت إذا لزم الأمر.

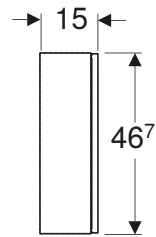
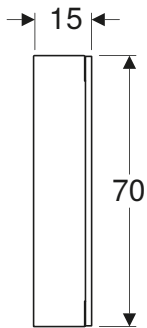
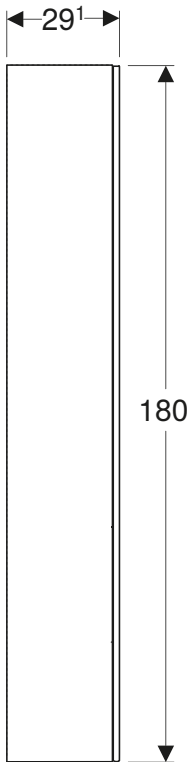
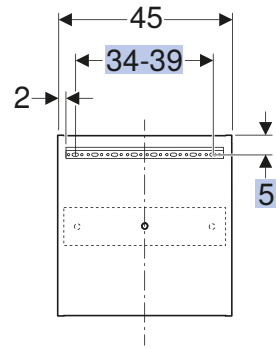
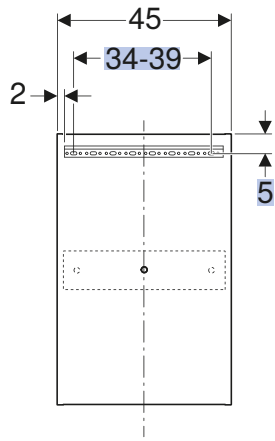
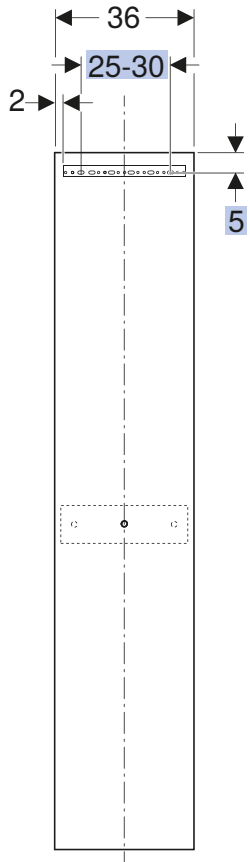
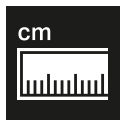

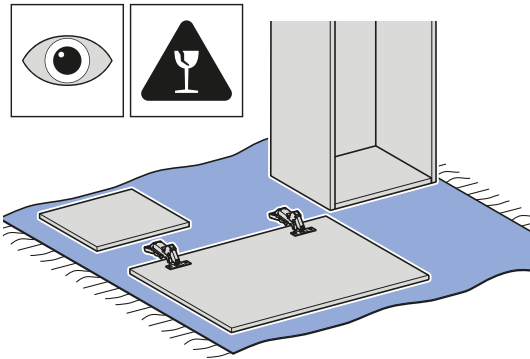

1

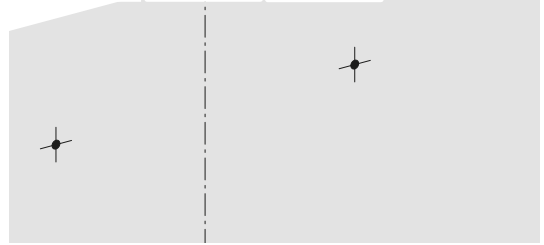
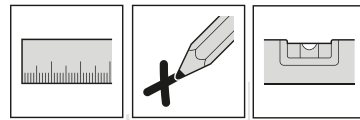
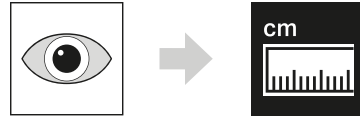

2

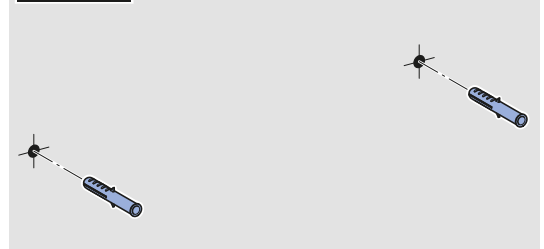
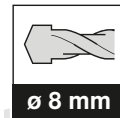

3

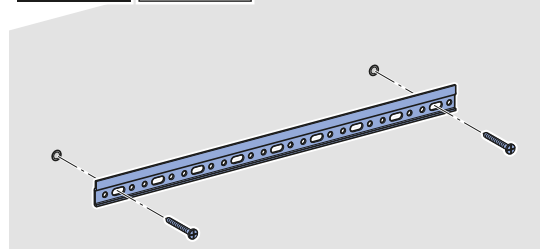
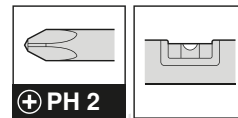

4

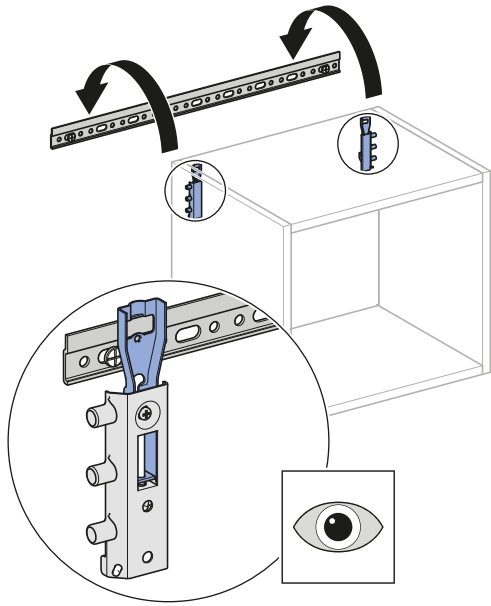

5

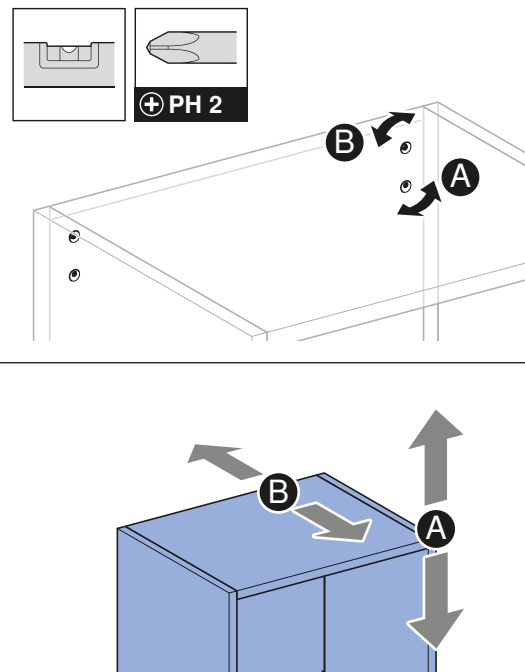

2

1

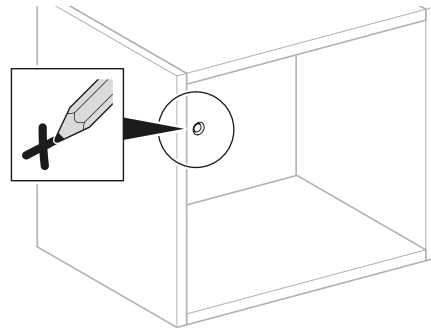

2

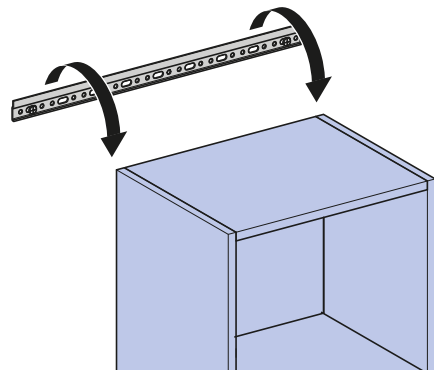

3

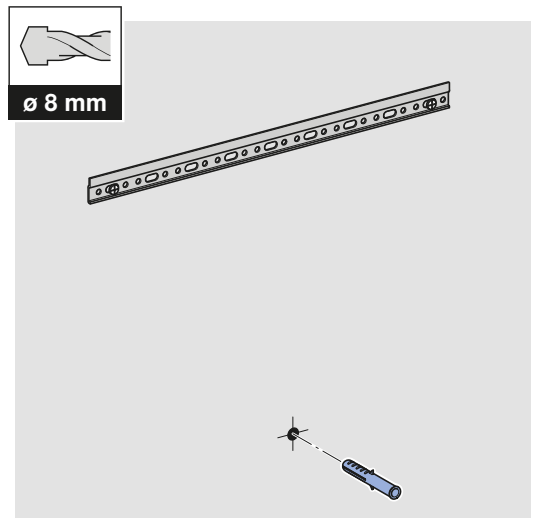

4

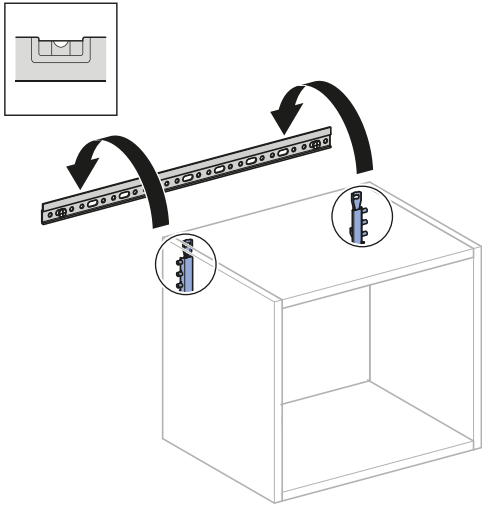

5

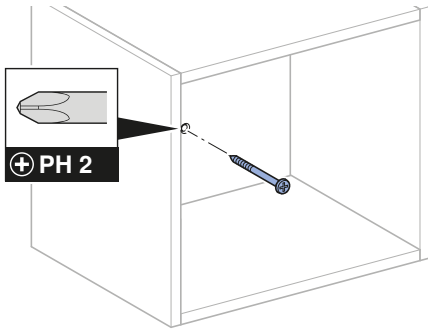

3

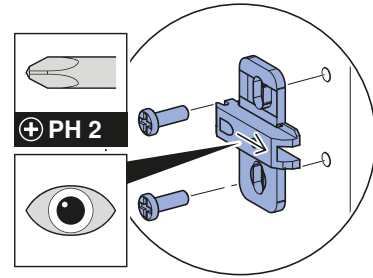
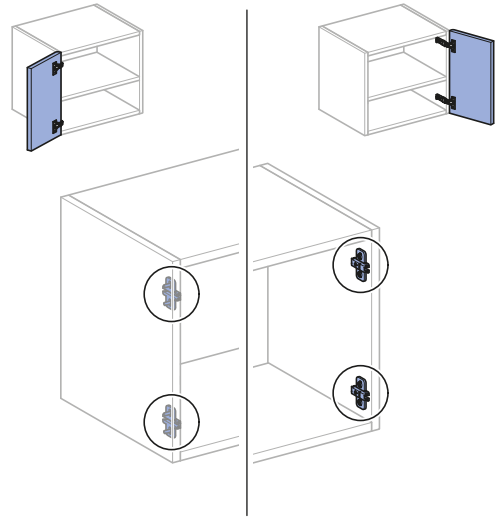

2

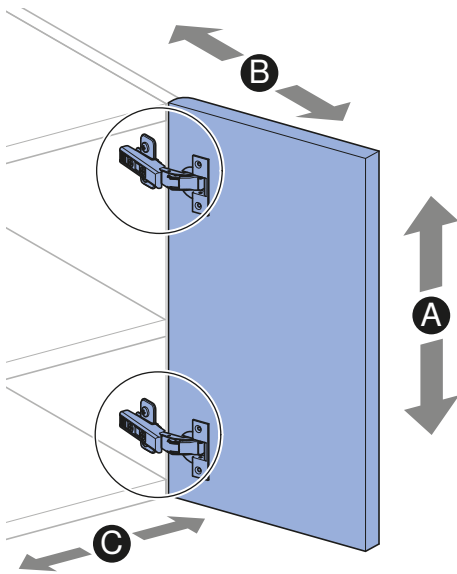
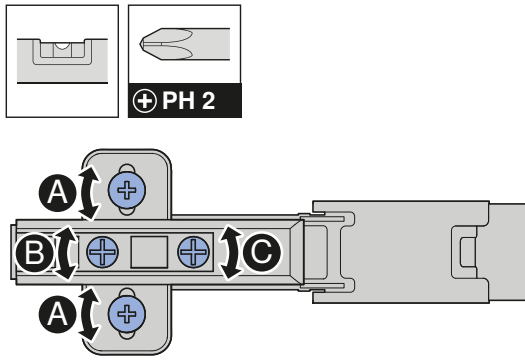

3

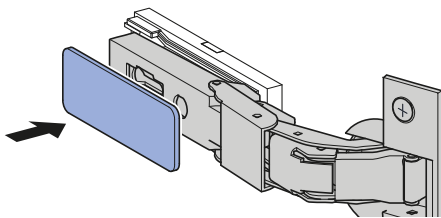

7

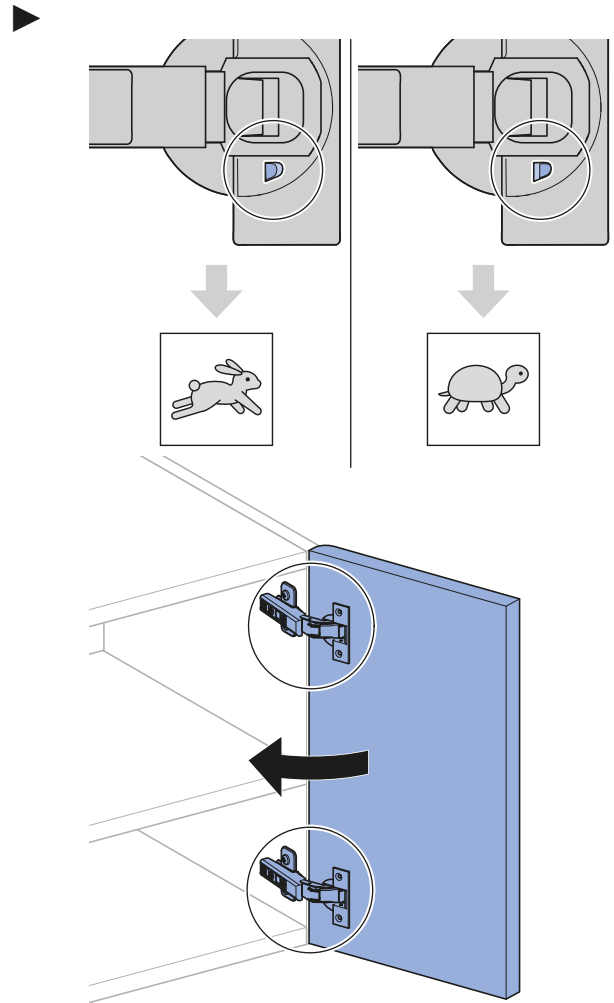

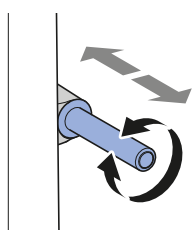
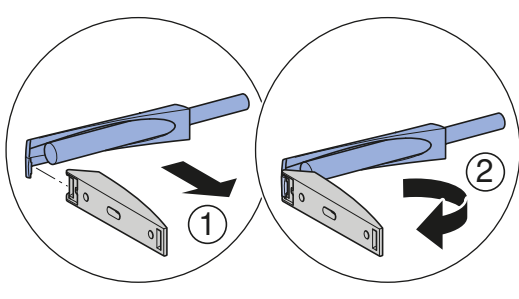
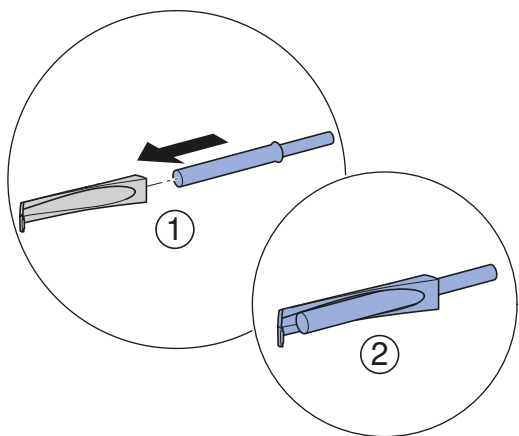
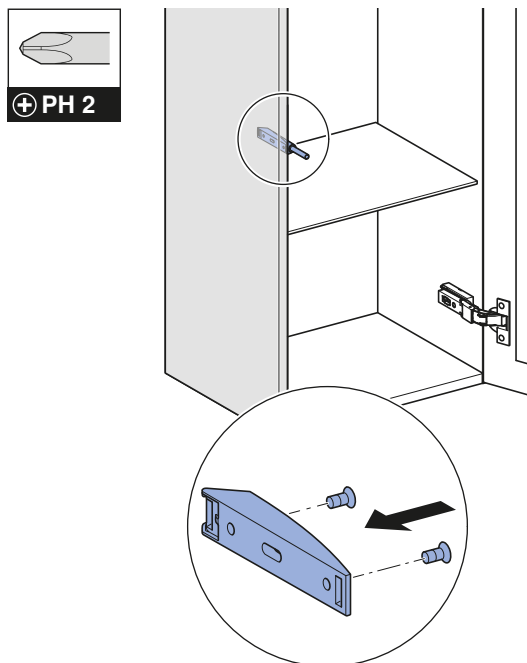

Geberit International AG
Schachenstrasse 77, CH-8645 Jona
documentation@geberit.com
www.geberit.com

