

STEINBERG



Kaltwasser-Armatur

Art.Nr.160 2500

Installation

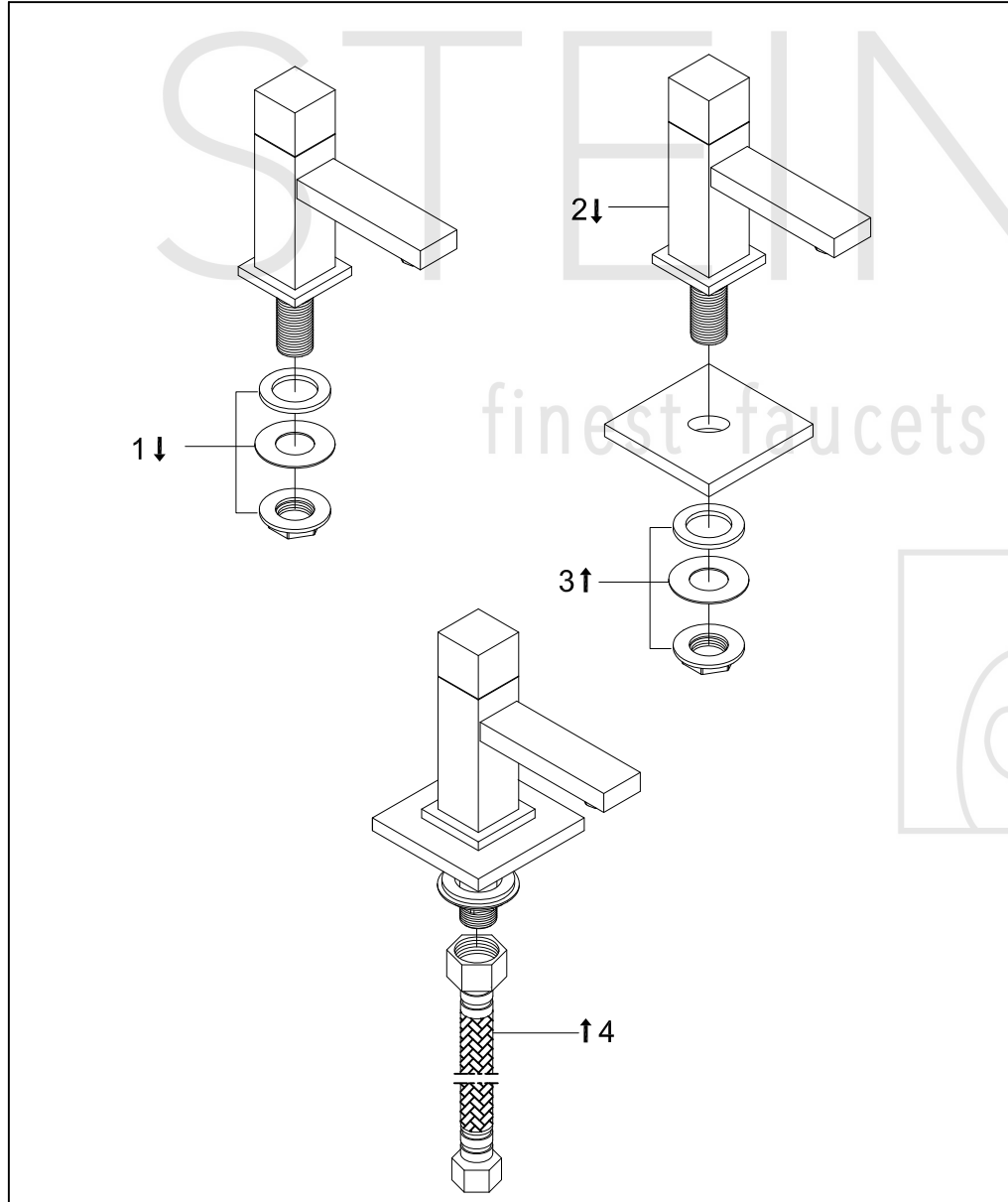

Technische Zeichnung

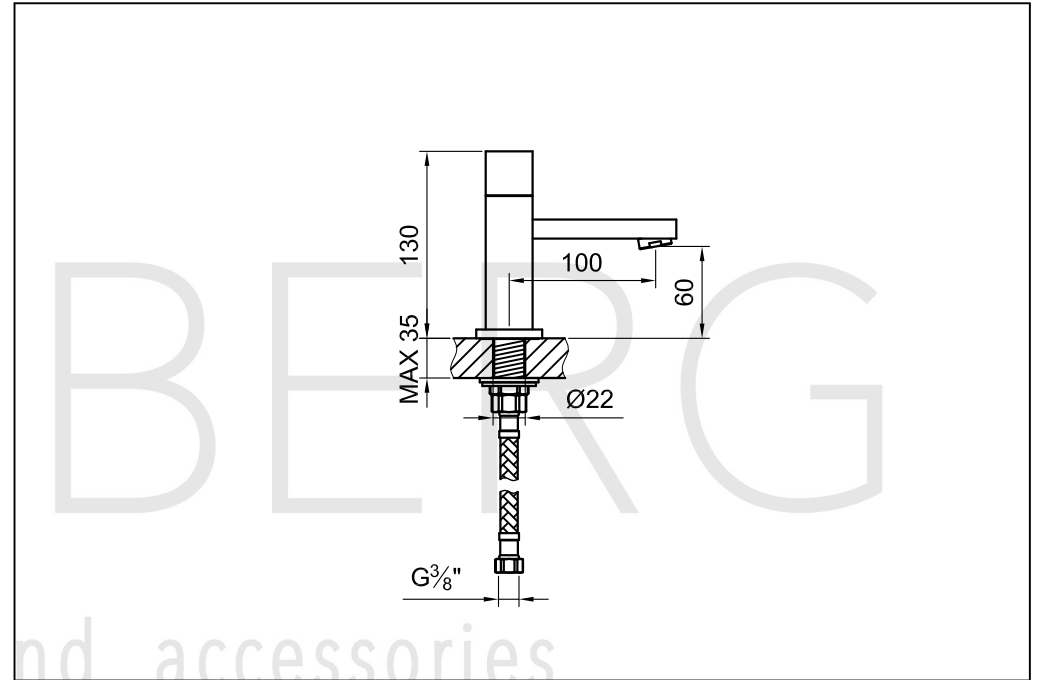

Explosionszeichnung

