

USER GUIDE

Electronic bidet toilet



VICLEAN^{U+}

BEYOND TECHNOLOGY

Powered by TOTO

Functions

Functions			VICLEAN ^{UP}
Basic Functions	Cleanse	Rearwash	●
		Rear soft cleanse	
		Ladywash	
	Changing the washing method	Nozzle position adjustment	●
		Water volume	
		Oscillating comfort wash	
		Pulsating wash	
User setting			
Drying	Warm air drying	●	
Changing the temperature	Adjustable water temperature / seat temperature / dryer temperature	●	
Sanitary Functions	Removing odours	Air purifier	●
Convenient Functions	Opening and closing	Remote controlled opening/ closing seat and lid	●
		Automatic open / close (seat and lid)	
	Lighting up	Night light	
	Heating the toilet seat	Heated seat	●
	Energy saving	Energy saver timer	●
Auto energy saver		●	
Maintenance	Removable toilet lid	●	
	Nozzle cleaning	●	
Design	Concealed connections	●	

Table of Contents

Introduction

Safety Precautions	4
Operational Precautions	10
Component Names	12
Preparation	14

Operation

Basic Operations	16
Automatic Functions	20
• Air purifier	20
• Auto open/close.....	20
• Night light	20
Temperature adjustment	22
Energy Saver Features	24

Maintenance

Plugs / Main unit.....	28
Gap between the Main Unit and the Toilet Lid	29
Air purifier filter	30
Nozzle cleaning	31
Filter cleaning.....	32

Reference

Changing Settings	34
What to Do?	46
• If you cannot operate with the remote control	46
• Freeze Damage Prevention	47
• Long Periods of Disuse	48
Troubleshooting	49
Important User Guidance Information Information.....	54
Specifications	55

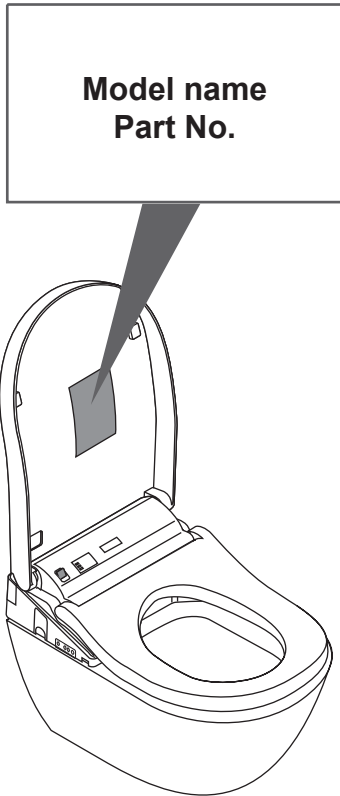

Safety Precautions

These precautions are important for safe usage. Be sure to follow them and use the product correctly.

Symbols and Meanings



WARNING

Incorrect use may result in death or serious injury.



CAUTION

May result in injury or property damage.

The following symbols are used to indicate important safety instructions for the use of the product.



This symbol indicates a prohibited use of the product.



This symbol indicates that specific actions are required to use the product.

- This product is classified as Class 1 Equipment and must be earthed.
- The power cable is 0.62m long. The device shall be installed near an accessible outlet. Please see the recommendation in the installation guide.
- This appliance is not intended for use by persons (including children) with reduced physical, sensory or mental capabilities, or lack of experience and knowledge, unless they have been given supervision or instruction concerning use of the appliance by a person responsible for their safety. Children should be supervised to ensure that they do not play with the appliance.
- Use the new hose set included with this equipment. Do not use old water supply hoses.



WARNING

Do not touch the power plug with wet hands.

- Doing so may cause an electrical shock.

Neither water nor cleaning agents may come in contact with the main unit and the plug.

- Doing so may cause fire, electrical shock, heat or short circuit.
- Doing so may damage the product resulting in injury or water damage.



Never disassemble, repair or alter.

- Doing so may cause fire, electrical shock, heat, short circuit or permanent damage. Do not install the product on vehicles such as wheeled vehicles or boats.
- Doing so may cause fire, electric shock, short circuit or malfunction.
- The toilet seat, toilet lid, main unit or other parts may come loose and fall off, resulting in injury.

Safety Precautions



WARNING

Do not use if a malfunction VICLEAN[®] occurs.

- Always keep the plugs separated and the switches on the distribution board in the OFF position.
- Close the water shut-off valve to stop water supply.

Possible malfunctions:

- Water is leaking from a pipe or the main unit.
 - The product is cracked or broken.
 - The product makes a strange noise or emits a strange odour.
 - The product emits smoke.
 - The product is abnormally hot.
 - The toilet seat cushion is out of place.
- Continued use after malfunction could cause a fire, electric shock, heat, short circuit, injury or water damage.

Only use tap water or potable well water (underground water).

Do not use seawater, industrial water or rainwater for the water supply.

- Doing so may cause irritation to the skin and malfunction.

Do not touch the power plug during thunderstorms.

- Doing so may cause an electrical shock.



The water supply hose may not come in contact with the plug.

- Doing so may cause condensation resulting in a fire, electrical shock, overheating or a short circuit.

Do not do anything that may damage the power cord, power plug.

Do not strike, yank, twist, excessively bend, damage, alter, or heat the electrical cords. Also, do not place anything heavy on, bind or pinch the electrical cords.

- Using a damaged electrical cord may result in electrical shock, short circuit and a fire.

Do not use a loose or faulty electrical plug.

- Doing so may cause fire or short circuit.

Do not use any outlets or wiring equipment beyond its specified rating.

Do not use any power supply other than the one specified.

AC 220V - 240V, 50Hz

- Doing so may cause fire or excessive heat.

Make save not to splash water, detergents or urine to the power supply.

- Doing so may cause an electrical shock.

Safety Precautions



WARNING

To reduce the danger of burns, death from electric shock, fire or other human injury:

- Do not use the product if the power cable or plug is faulty, if it is not working properly, if it has fallen to the ground or was damaged or it has fallen into water. Return the product to Villeroy & Boch AG for examination and repair.
- Never block the air openings of the product or place it on a soft surface, such as a bed or a couch, where the air openings could be blocked. Keep the air openings free of lint, hair or a similar material.
- Never use it while sleepy or drowsy.
- Never drop or insert anything into any opening or hose.
- Do not use it outdoors where aerosol (spray) products are being used or where oxygen is being administered.



Do not bend or distort the nozzle.

- Doing so may cause product damage and performance reduction.

Do not place anything on the warm air dryer or drape clothes over it.

- Doing so may cause burns, electrical shock or malfunction.

Keep cigarettes and other open flames away from the product.

Do not place a heater near the product.

- Failure to do so may cause fire.

Beware of irritation or burn

- Improper use of the toilet seat may cause irritation or burn.

When sitting for a long time on the toilet seat, switch the toilet seat temperature adjustment to OFF. Should one of the groups listed below use the heated toilet seat or the hot air dryer, the toilet seat temperatures adjustment should be switched to OFF and the dryer temperature to "low".

- Young children, the aged and other users unable to set the temperature appropriately themselves.
- The ill, physically disabled and others who do not have freedom of movement.
- Those using any medicines that cause drowsiness (sleeping or cold medicine), those who have been drinking heavily, anyone severely fatigued and anyone else liable to fall asleep.



To reduce the danger of burns, death from electric shock, fire or other human injury:

- Close supervision is necessary when this product is used by or near children or handicapped individuals.
- Use this product only for its intended use as described in this manual. Do not use accessories not recommended by the manufacturer.
- Keep the cord away from heated surfaces.
- Connect this product to a properly earthed outlet only.
- The tank should only be filled with water.

Safety Precautions



WARNING

This is an electrical product. Do not install it anywhere water is likely to get on the product or anywhere with humidity high enough that water is likely to form on the surface of this product. If the product is located in a bathroom, install a fan or ventilation unit and ensure good air flow through the bathroom.

- Failure to do so may cause fire or electrical shock.

Always connect to the cold water supply VICLEAN[®].

- Connecting to hot water supply may result in burns and equipment damage.

Electrical power supply should be established by qualified electrical personnel.

Check that it is appropriately earthed.

- If the ground is not installed, if there is a breakdown or electrical current leak, the lack of a ground could cause electrical shock.
- For the ground, use copper wire with a earth resistance of 100 Ω max. and a diameter of 1.6 mm min.
- If there is no ground installed, ask the contractor who did the installation to install the ground.

Make sure that a properly earthed (3-pole) plug is available.

- Failure to use an earthed outlet could cause electrical shock in the event of a malfunction or short circuit.



Check whether the outlets for power supply meet the following requirements.

- Failure to do so may cause fire or electrical shock.
 - a. Apply a current to the outlet (or device) through a differential residual current device (RCD) whose release current does not exceed 30 mA.
 - b. Install the outlet (or device) and its wiring plug at least 0.60 m away from the outside of the shower tub or bathtub.
 - c. Check that the wiring for a. and b. above is complete. If the wiring has not been completed, ask the contractor who did the installation to do it.

Insert the power plug securely into the outlet.

Check that the power cord is connected.

- Failure to do so may cause fire, heat or short circuit.
- When installing this product, observe the local laws and regulations regarding installation.

To unplug, hold the plug, not the cord.

- Do not pull out plug by the cord.
- Pulling on the cord may cause damage and result in fire or heat.

Do not use wet hands to insert or remove power plug.

- Doing so may cause an electrical shock.

If the cable is damaged, do not take any risks! Have the repair department or equivalent specialist replace it.

Safety Precautions



WARNING



Before, cleaning, servicing or inspecting the product, always place the switch on the distribution board to OFF (except for use of "Nozzle cleaning").

- Failure to do so may cause electrical shock or malfunction.



CAUTION

Do not use the product if the main unit is unstable.

- Doing so may cause the main unit to come loose and fall, resulting in injury.
- If there is back flash in the main unit, consult the installer, seller or the contact listed on the back cover of this manual.

If the product is damaged, do not touch the damaged section.

- Failure to do so may cause electrical shock or malfunction.
- Replace damaged element immediately.

Do not apply strong force, mechanical shock, step on or stand on the toilet seat, toilet lid or main unit. Also do not place any heavy object on the toilet seat, toilet lid or main unit.

- Doing so may cause cracking or cause the main unit to come loose and fall, resulting in injury.
- Doing so may damage the product and cause injury or water damage.



Do not lift up this product by the toilet seat or lid. Do not raise the toilet seat or lid while objects are resting on top of the toilet.

- Doing so may cause the main unit to come loose and fall, resulting in injury.

To reduce the danger of death from electric shock:

- Do not use while bathing.
- Do not place or store the product where it could fall or be pulled into a tub or sink.
- Do not put in or drop into water or other liquid.
- Do not try to recover the product if it has fallen into water. Switch the breaker on the distribution board to OFF immediately.

To prevent a sudden water leak, do not remove the water supply hose or clean the filter when the shut-off valve is open.

- Doing so will cause water to spurt out. (Refer to page 32: Cleaning the filter)

Do not fold or crush the water supply hose; do not damage by cutting with a sharp object.

- Doing so may cause water leaks.

Safety Precautions



CAUTION

If a water leak should occur, always close the shut-off valve.

When the ambient temperature is likely to drop to 0°C or lower, prevent damage to the pipes and hoses due to freezing.

- Frozen water pipes could cause the main unit and the pipes to break, resulting in a water leak.
- Regulate the room temperature to prevent the pipes and hoses from freezing during cold months.
- Drain the water.

When not using VICLEAN[™] over an extended period of time, drain the water out of the main unit and the water supply hose after closing the water shut-off valve.

- Switch the breaker on the distribution board to OFF.
- Leaving the power on may cause fire or heat.



When using the product again, allow the product to refill with water first (see page 48: Notes on filling with water).

- Otherwise, the water in the tank might become contaminated and cause skin inflammation or other problems.

When installing the water filter, make sure that it is securely tightened in its proper position.

- Failure to securely tighten it may cause water leaks.

Operational Precautions

For prevention of malfunctions

- Do not block the body sensor, the remote control transmitter and receiver.

About the body sensors

Two types of body sensors are used.

Body sensor A detects changes in heat.

- Detection may be difficult when the room temperature exceeds 30°C, such as in the summertime.
- When sunlight is directly on the sensor area or a heater is used in the bathroom, the sensor may detect incorrectly due to the heat, resulting in the automatic operation of functions such as auto lid opening and closing.

Body sensor B detects when someone stands in front of the bidet toilet.

- Body sensor B emits an infra-red beam as shown in the figure. People who move through the beam are detected by the sensor (sensor detection may be difficult if the toilet is used by smaller people such as children).

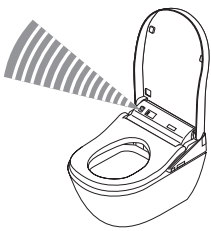

Body sensor A



Body sensor B

Seat switch

- When you sit on the toilet seat, the seat switch turns ON, enabling you to use various features. (A click sound is heard when the seat switch is ACTIVATED).

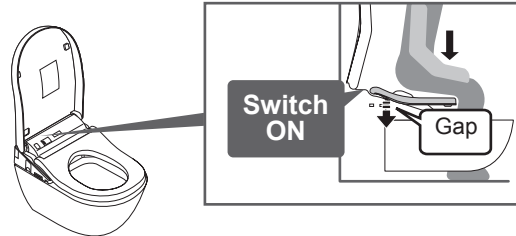

Sit back on the toilet seat.

- The seat switch will not turn on unless you sit on the seat properly.



- When a child uses VICLEAN[®], the seat switch may not be ACTIVATED by their light body weight.
- This seat switch creates a gap between the soft-closing device and the toilet.

For prevention of damage

- Do not lean against the toilet lid.

Problem Prevention

- Switch the breaker on the distribution board to OFF.
- A toilet seat cover or a toilet lid cover cannot be used. (The body sensors or seat switch may not function properly.)

Do not cover!

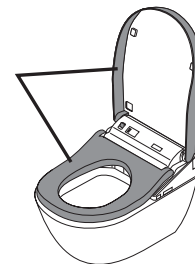

Operational Precautions

- Do not urinate on the main unit, toilet seat or nozzle.
(Doing so may cause pink or brown stains or a malfunction.)
- Do not apply strong forces to the control panel of the remote control.
- Do not expose to direct sunlight. (Doing so may cause changes in colour, irregular seat temperature, remote control malfunction or VICLEAN™ malfunction due to the change in temperature.)
- Do not use radios, etc. near VICLEAN™. VICLEAN™ could cause interference with reception.
- Should a child seat or a soft assistance seat be used, it needs to be removed after usage.
(Keeping it installed may prevent some of the functions from being used.)
- Do not apply force to the remote control. It may cause malfunctions.
To prevent the remote control from being dropped, set it in the hanger when you are not using it. Be careful not to expose it to water.

About rearwash, rear soft cleanse and ladywash

- These functions wash away waste and dirt from a localized area of your body.
- Do not cleanse too much or for too long. Doing so may remove normal bacteria, which may disrupt the bacterial balance in your body.
- People receiving medical treatment on the relevant areas should consult their doctors before using.

Cleaning instructions

This bidet toilet has been designed and manufactured with great care and attention to detail. If you follow a few simple cleaning instruction you will be able to enjoy its comfort, quality and beauty every day.

- In order to ensure the best possible hygiene the surface of your bidet toilet is closed and pore-free. Do not use sanitary cleaners, household cleaners, benzene, paint thinner, powdered cleaning agents with abrasives or abrasive sponges made from nylon. These products may damage or crack the plastic, and lead to injury or malfunction. Only use mild pH neutral soap for cleaning.
- Wipe plastic areas such as the main unit and remote control with a soft and damp cloth or tissue.
- After cleaning please dry off any residual dampness with a soft cloth.
- Should the toilet seat or cover come into contact with sanitary cleaner or other aggressive cleaning agents rinse the area immediately with clear water.
- When using a toilet cleaner to clean the toilet, wash it off within 3 minutes.
Seat and cover must be left open. Should vapour from the sanitary cleaner rise from the toilet bowl and get into the main unit, it may cause malfunctions.

Component Names

Main Display

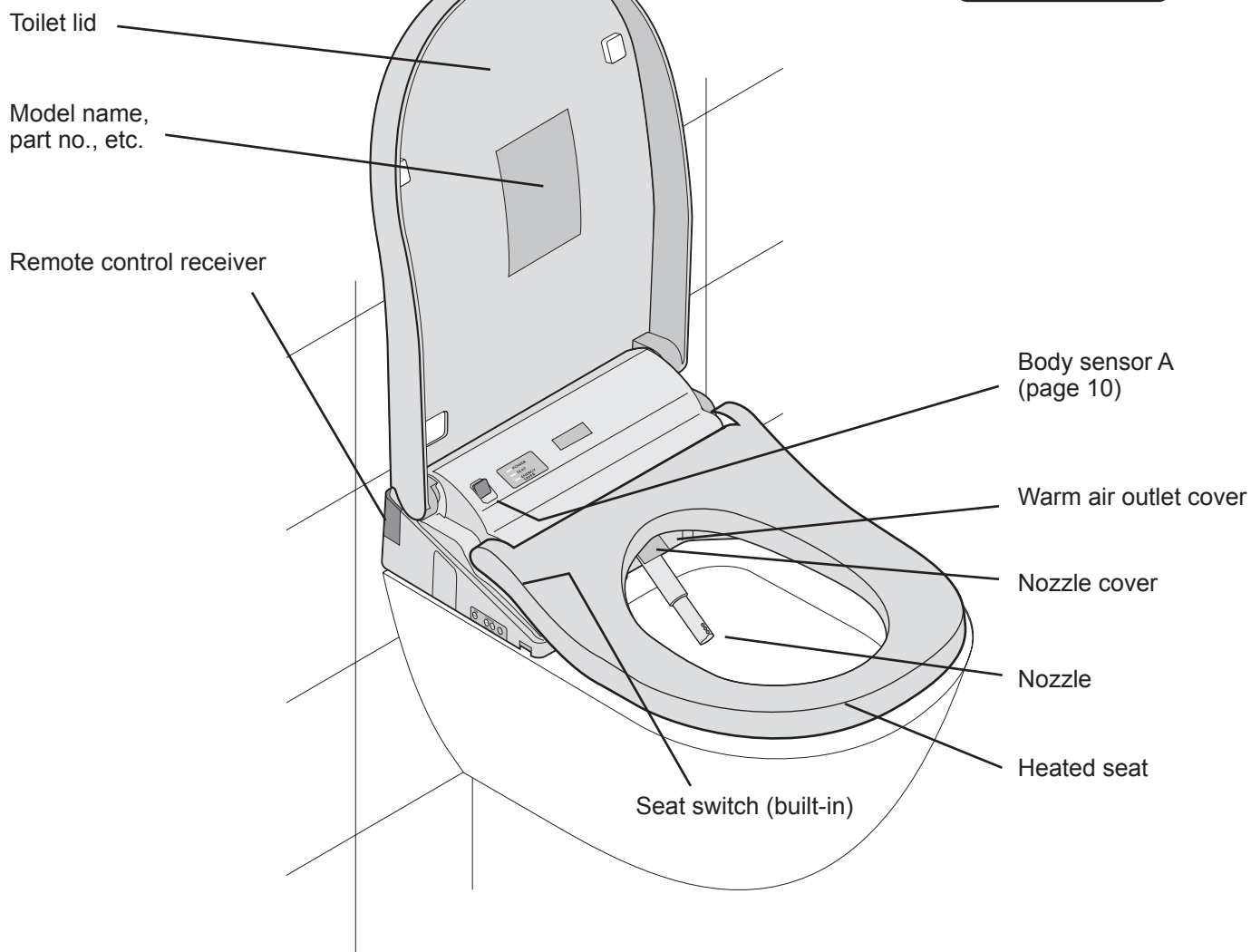
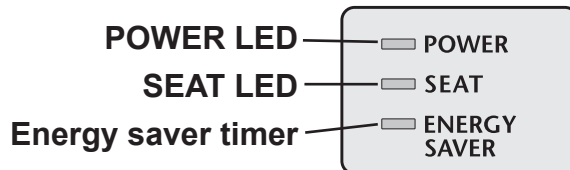

Left side of main unit

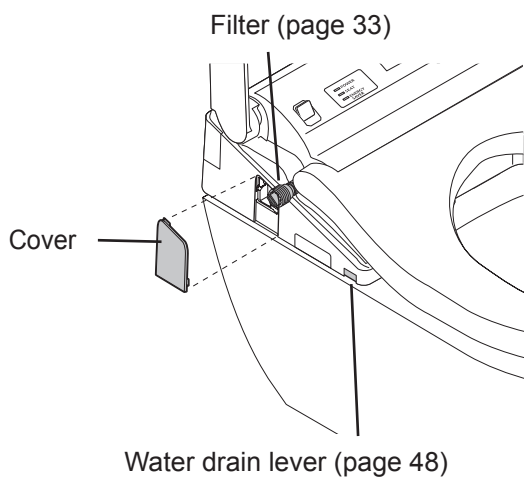

Control panel

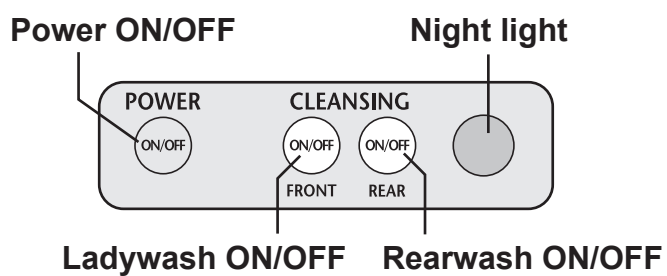

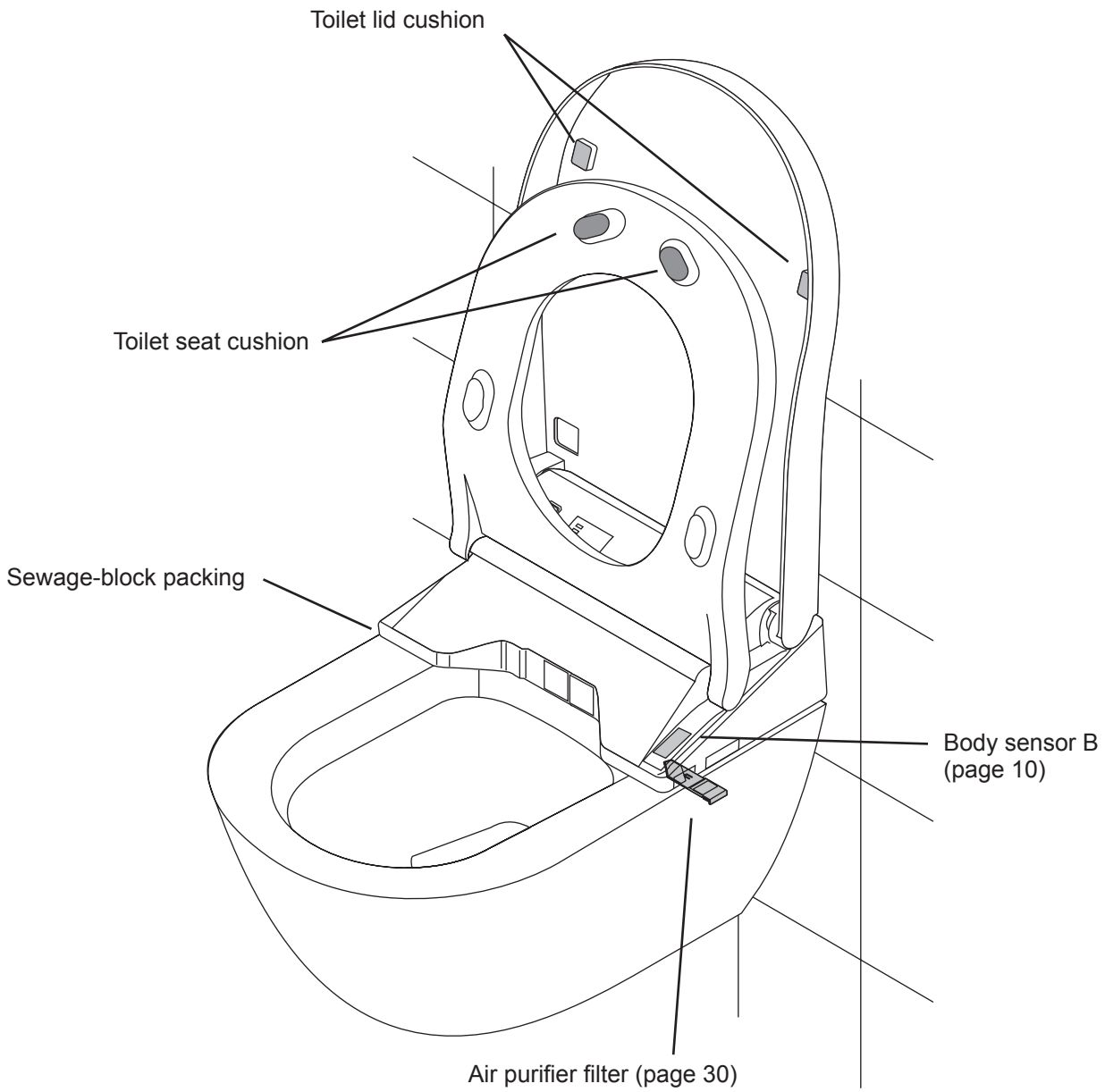

Right side of main unit

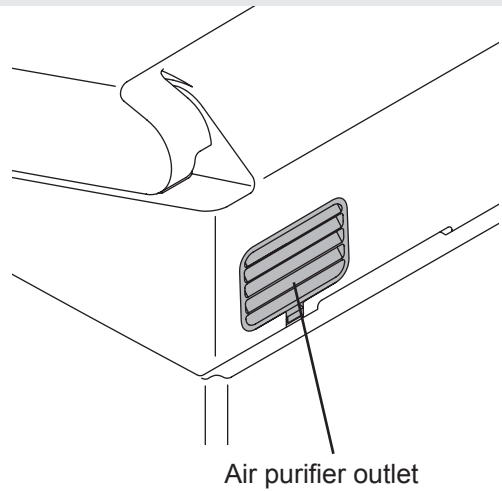

Preparation (Using the Product for the First Time)

1 Insert the batteries

1. Remove the remote control from the hanger.

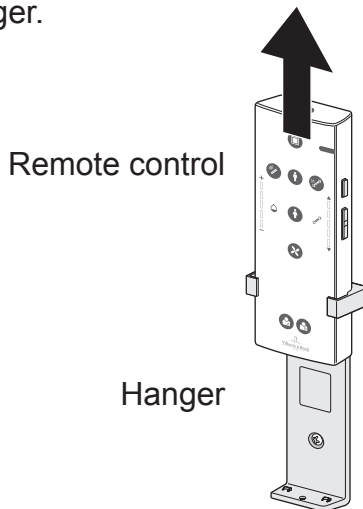

2. Open battery tray and insert two AA batteries.

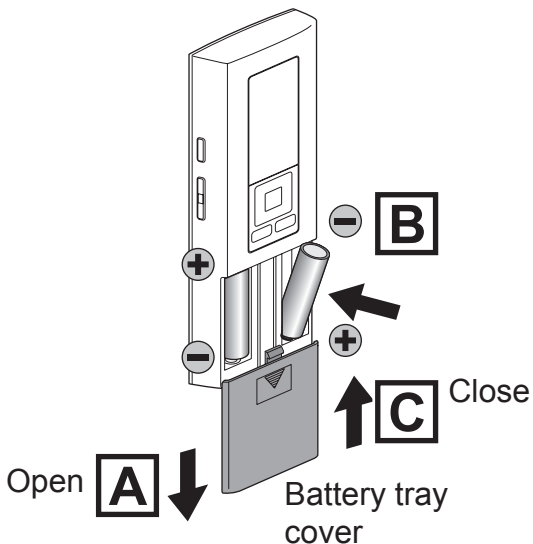

- When batteries are properly inserted, temperature levels appear on the display of the remote control (back side).
- The display goes out when no button on the remote control is pressed for 5 minutes or more.

3. Mount the remote control in the hanger.

About the batteries

- Use dry cell, alkaline batteries. Follow the instructions below to prevent the batteries from rupturing or leaking fluid.
- When replacing the batteries, use new batteries of the same brand.
- If you will not be using the remote control for a long time, remove the batteries.
- Do not use rechargeable batteries.

If the remote control is secured (for anti theft)

1. Remove the screw from the remote control fixture.

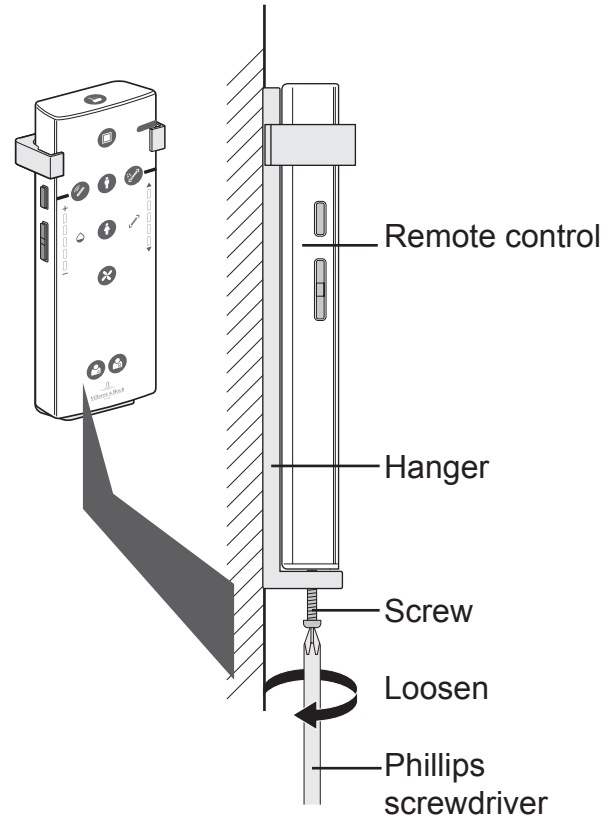

2. Remove the remote control from the hanger.

To secure the remote control again

Tighten the screw.

(Over-tightening may cause damage to parts such as the hanger)

2 Turn on the power

1. Connect the plug.
Set the switch in the distribution board to ON.
 - The nozzle extends and then retracts

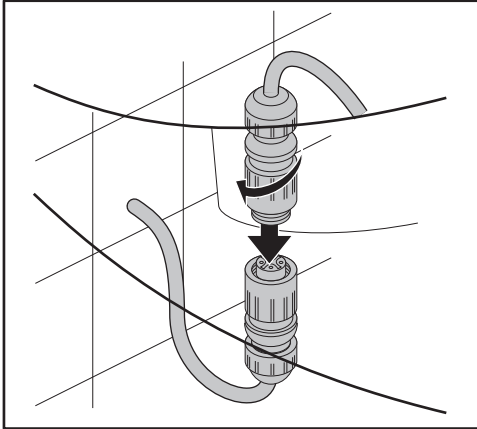

3 Open the shut-off valve

Fully open the shut-off valve.

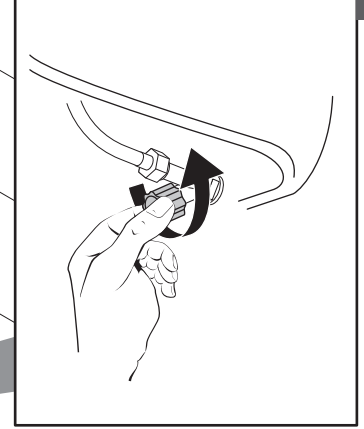

2. Check that the POWER LED on the main display is lit.
 - If it does not light up, press [POWER ON/OFF] to light it up.

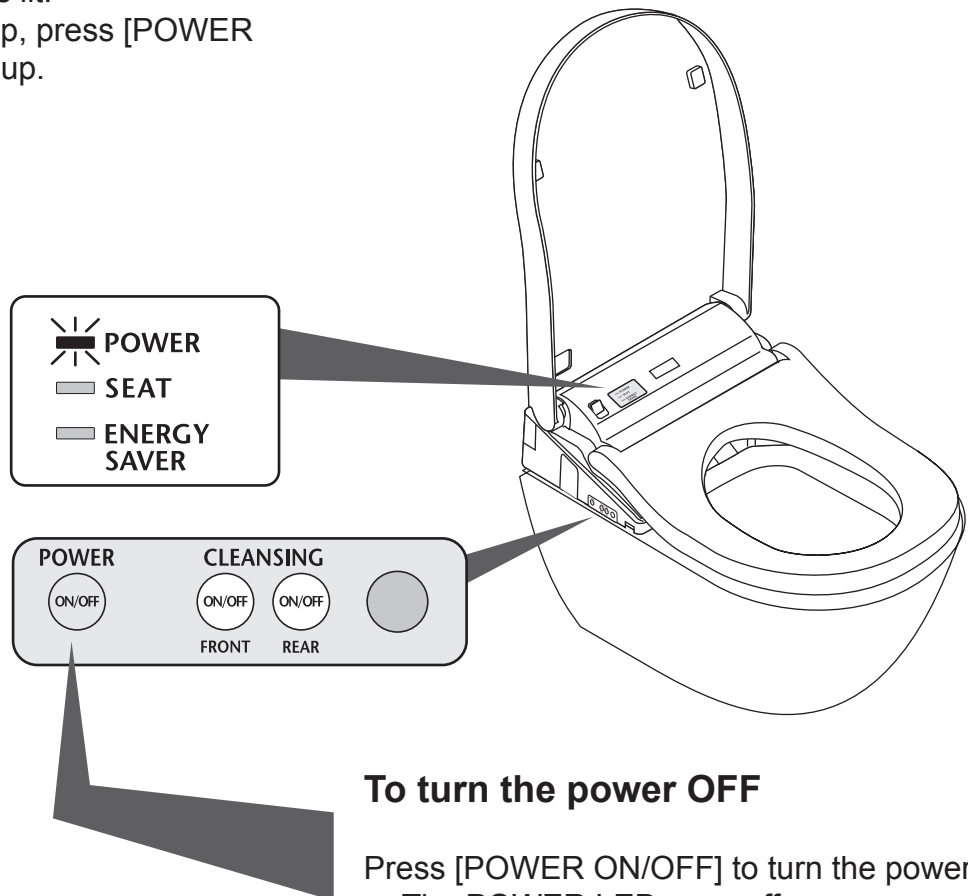

To turn the power OFF

- Press [POWER ON/OFF] to turn the power off.
- The POWER LED goes off.

Basic Operations

Press a button on the remote control. A beep sounds when the main unit receives the signal.

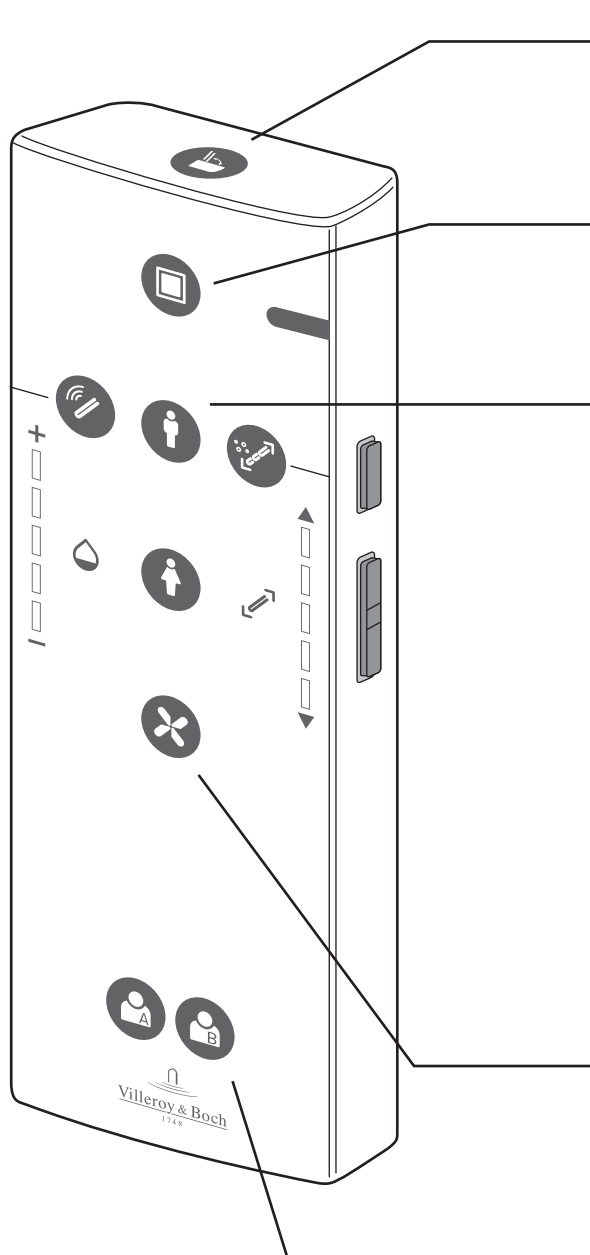

Opening and closing



[SEAT & LID OPEN/CLOSE]

Opens and closes the toilet seat.

Stopping



[STOP]

Stops the operation.

Cleanse

[REARWASH]

Cleanses your rear.



[SOFT CLEANSE]

Washes your rear with mild water pressure.

The mode changes between [SOFT CLEANSE] (flickering) and [REARWASH] (steady on) each time the button is pressed.



[LADYWASH]

Serves as a bidet for ladies.

Drying



[WARM AIR DRYER]

Dries your rear.

Personal setting lock



[USER1] / [USER2]

You can store your preferred nozzle position, water pressure and water temperature.

- To store a setting
While cleanse is in progress, set your preferred nozzle position, water pressure, and warm water temperature, and then press and hold [USER 1] or [USER 2] for 2 seconds or longer. (The nozzle position and water pressure lamps will light up for about 10 seconds in their set positions, and the water temperature display switches).
- To use
Press [USER 1] or [USER 2], and then press the button for the cleanse you want to use.

Functions that operate when a button is pressed, such as REARWASH, SOFT CLEANSE or LADYWASH.

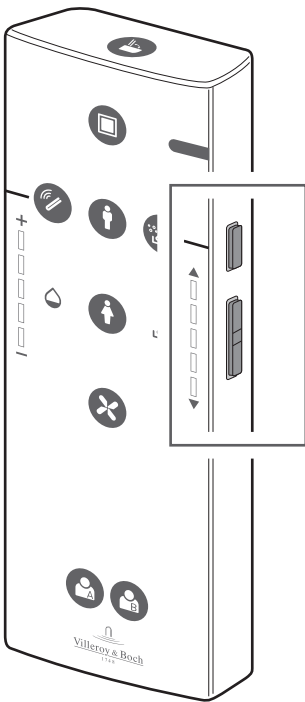

[OSCILLATING COMFORT WASH]

- The nozzle moves back and forth to wash your rear thoroughly.
- The setting changes between „ON“ and „OFF“ each time the button is pressed.

[NOZZLE POSITION]

- The nozzle position can be adjusted to the front or rear.
- “▲”: moves to the front
- “▼”: moves to the rear

[PULSATING MASSAGE SHOWER]

- The washing pressure pulsates between soft and strong.
- The setting changes between „ON“ and „OFF“ each time the button is pressed.

[WATER JET PRESSURE]

- Just as for “REARWASH”, water pressure strength can be adjusted for this cleanse functions.
- “-” : softer
- “+”: stronger

Note:

- Sitting back on the toilet seat makes it easier to adjust the nozzle position and to reduce splashing.

Basic Operations (About the Menu Screen)

This section is an overview of the settings that can be configured with the remote control.

- See the corresponding pages for the detailed descriptions.

Remote control back side

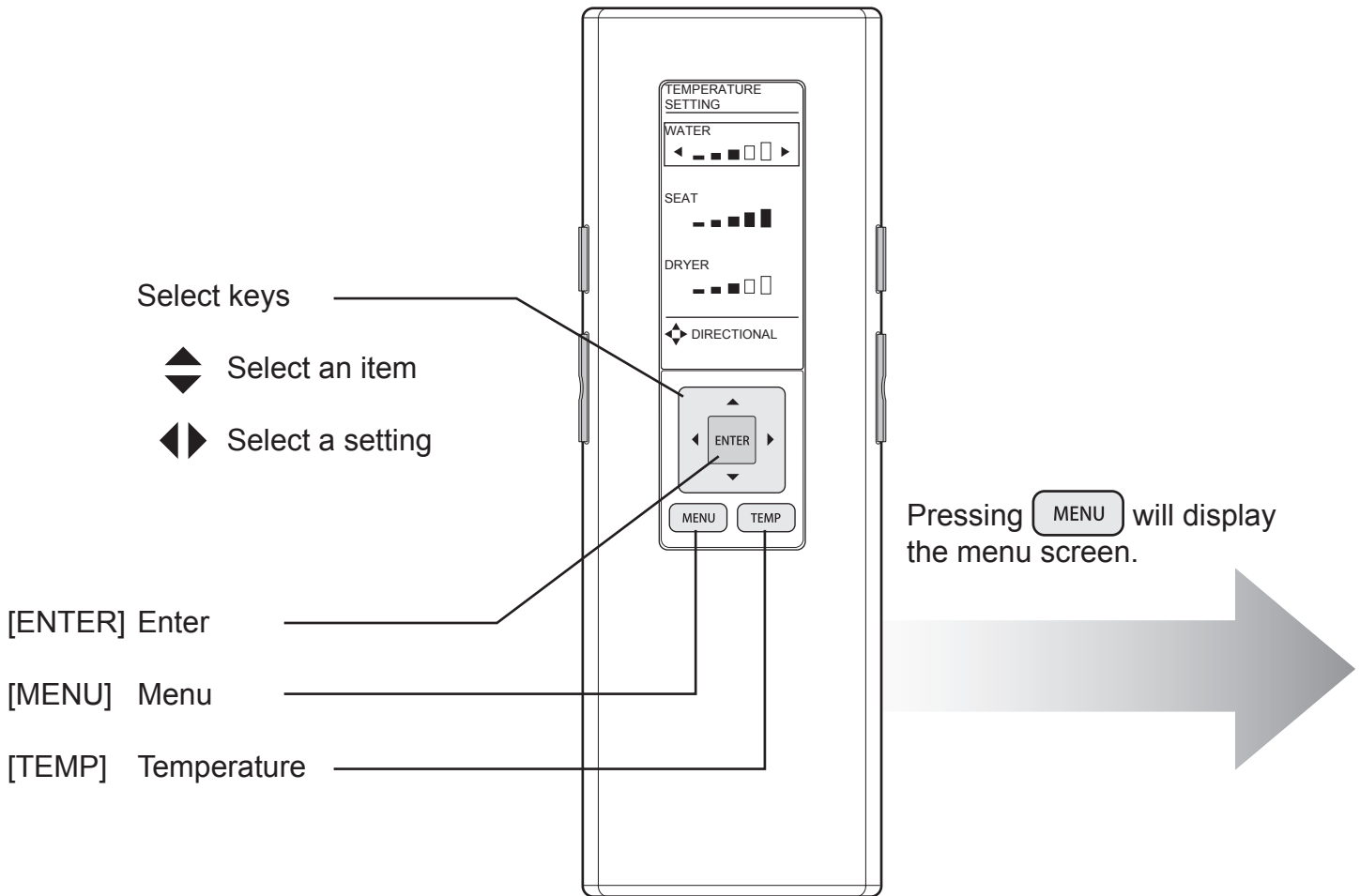

Setting lock

You can lock the settings so that you do not mistakenly operate the rear buttons while using the remote control.

On how to set see page 44.

Display screen during setting lock

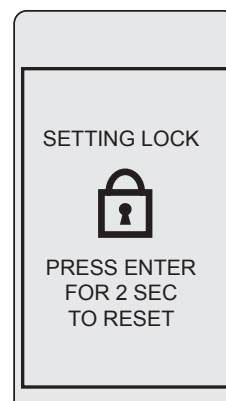



LEVEL 1

LEVEL 2

LEVEL 3

MENU 1/4

- 1. CLEANING
- 2. ENERGY SAVER
- 3. AUTO FUNCTIONS
- 4. OTHER SETTINGS

(page 34-35)

CLEANING 1/1

WAND
CLEANING
MODE ON/OFF

(page 31)

ENERGY SAVER 1/2

1. AUTO ENERGY SAVER
◀ OFF ▶

2. TIMER SAVER
◀ OFF ▶

(page 24-27)

AUTO FUNCTIONS 1/3

1. AUTO OPEN/CLOSE

2. CLEANING

3. LIGHT

(page 20-21)

OTHER SETTINGS 1/3

1. BEEP
◀ ON ▶

2. SETTING LOCK
◀ ON ▶

3. PERSONAL SETTING LOCK
◀ ON ▶

(page 44-45)

AUTO OPEN/CLOSE 1/4

1. AUTO OPEN/CLOSE
◀ ON ▶

2. AUTO CLOSE WAITING TIME
◀ 90SEC ▶

3. AUTO OPEN WAITING TIME
◀ 15SEC ▶

4. SEAT/LID LID ▶

(page 36-39)

CLEANING 1/1

1. DEODORIZER
◀ ON ▶

(page 40-41)

LIGHT 1/1

1. NIGHT LIGHT
◀ ON ▶

(page 42-43)

Operation

Automatic Functions (Cleaning Features)

Various automatic functions are available, such as a toilet lid that opens and closes automatically. Operation under the initial settings is described below.

As you approach

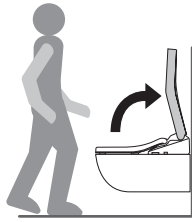

As you sit*



As you stand up



AUTO OPEN/ CLOSE

Automatic
Opening/closing

When using the toilet seat

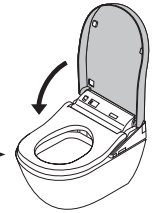
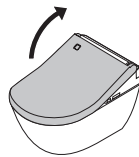

The toilet lid will close about 90 seconds after you stand up from the toilet seat.

When standing to urinate

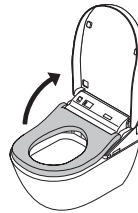
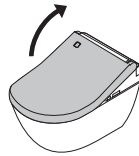

The toilet lid opens
Open the toilet seat with the remote control.

AIR PURIFIER

Air purifier



Starts the air purifier

The air purifier stops.
It stops after about 2 minutes.

NIGHT LIGHT

Night light

Lights up in
middle mode



Lights up in
high mode



Lights up in middle mode
(after about 90 seconds)



* Water comes out from around the nozzle.

As you move away

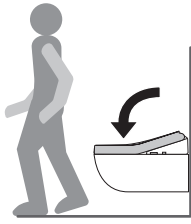

If dirt adheres to the nozzle during use, you can extend the nozzle to clean it.

- Cleaning the nozzle (page 31)

Note

Changing settings

- When the room temperature reaches about 30°C or higher, the body sensor may not detect properly. (In this case open manually.)
- When the toilet lid is closed with the remote control or by hand, it cannot open automatically for about 15 seconds. (In this case open manually.)
- When you do not sit on the toilet seat, or when you sit on it only briefly or stand in front of the toilet bowl, it takes about 5 minutes before the lid closes automatically.

AUTO OPEN/CLOSE ON/OFF

AUTO CLOSE DELAY (15 seconds, 30 seconds or 90 seconds)

AUTO CLOSE DELAY (25 seconds or 90 seconds)

Automatic opening of the toilet lid or both the toilet seat and toilet lid (page 38)

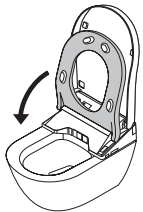

The toilet cover and the toilet seat will close within about 90 seconds after the user is about 30 cm away from the toilet seat.

AIR PURIFIER ON/OFF (page 40)

Lights up in low mode (goes out after about 5 seconds.)



NIGHT LIGHT ON/OFF (page 42)

Temperature Adjustment (Warm Water / Toilet Seat / Warm Air Dryer)

You can adjust the temperature levels or turn the settings to "OFF".

1 Press **TEMP**

2 Use  to select the item you want to set.

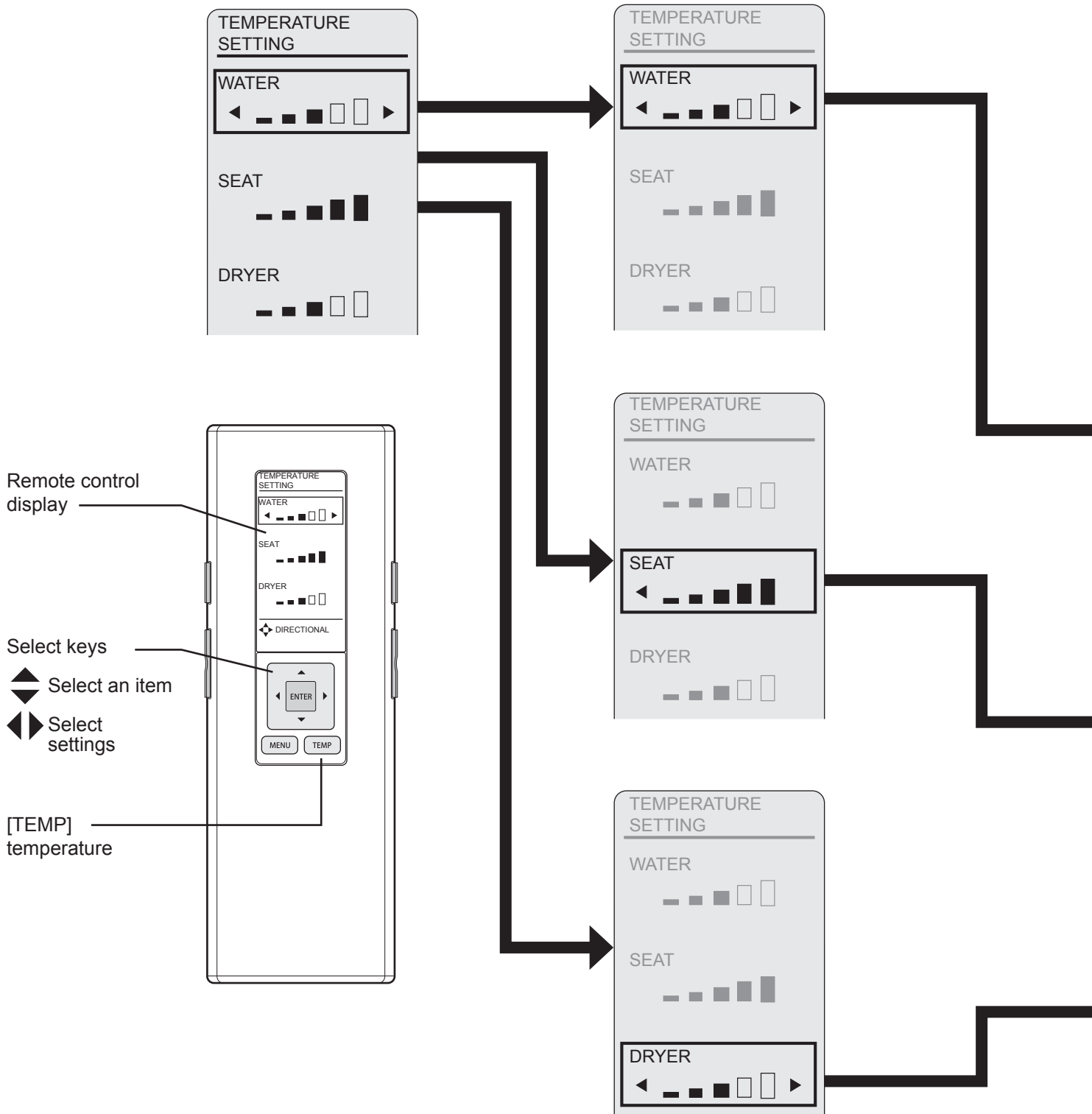

3



Use ◀▶ to select the item you want to set.

4

Settings complete.

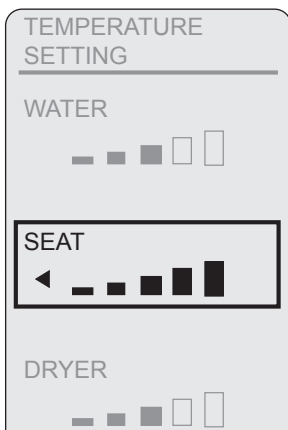

Warm water temperature*

Press ◀ until "OFF" appears.



OFF ◀▶ Low ◀────────────────▶ High

Toilet seat temperature

Press ◀ until "OFF" appears.



OFF ◀▶ Low ◀────────────────▶ High

When "OFF" is set, the SEAT LED will go off.

Warm air dryer temperature



Low ◀────────────────▶ High

* To prevent condensation, the water temperature does not drop below 20°C even when set to OFF.

Energy Saver Features (Modes)

You can save energy by turning the toilet seat heater to a low temperature (or turning the heater „OFF“) during periods when the toilet will be used infrequently.

- It takes about 10 days for the product to determine the periods when it is used relatively less frequently.

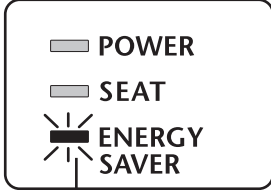
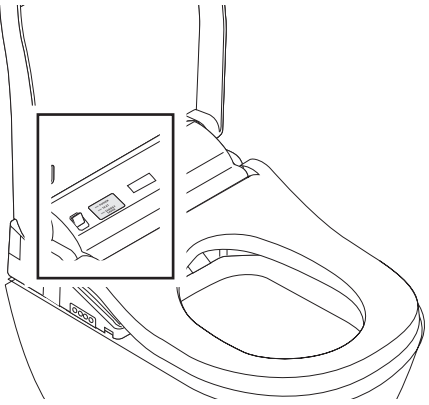
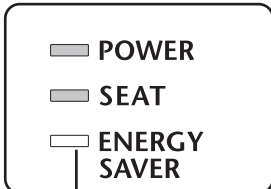
Mode	Situation	When energy saver is set	
		Main Display	
AUTO ENERGY SAVER	<p>You want to save energy but dislike a cold toilet seat *</p> <p>VICLEAN™ will notice periods of low use and reduce the toilet seat temperature automatically.</p>	 <p>Green</p>	→
TIMER ENERGY SAVER	<p>You want to save energy only for the pre-set duration of time.</p> <p>If you set the duration of time (3 hours, 6 hours or 9 hours) during which you want to save energy, the heater automatically turns off every day in the set time slot.</p>		→
AUTO ENERGY SAVER + TIMER ENERGY SAVER	<p>You want to save a lot of energy with auto energy saver and energy saver timer</p> <p>When both timer energy saver and auto energy saver are set, auto energy saver operates when timer energy saver is not operating.</p>	<p>When the energy saver is not set</p>  <p>Off</p>	→

*Even if the toilet seat heater is set to "Low" or "OFF", the toilet seat is temporarily heated when you sit down.

When energy saver is in operation		AM		PM			
Toilet seat heater		24	6	8	17	21	24
<p>Green</p> <p>Orange</p>		<p>Example: Used infrequently from 9 pm to 6 am</p>					
		Low temperature ^{*2}	Set temperature ^{*1}				Low temperature ^{*2}
<p>Green</p>		<p>Example: Set from 8 am to 5 pm</p>					
		Set temperature ^{*1}			Set temperature ^{*1}		
				OFF ^{*3}			
<ul style="list-style-type: none"> • With energy saver timer: Same LED indication as energy saver timer (See above) • With auto energy saver: Same LED indication as auto energy saver 	 	<p>Example: When the energy saver timer and the auto energy saver are used simultaneously</p>					
		Low temperature ^{*2}	Set temperature ^{*1}		Set temperature ^{*1}		Low temperature ^{*2}
				OFF ^{*3}			

*1 The toilet seat temperature set on page 22.

*2 The time period when the toilet seat heater is set to a low temperature by the auto energy saver.

*3 The time period when the toilet seat heater is off ("OFF").

To set energy saver page 26 / 27

Energy Saver Features (Settings)

Set the timer energy saver at the time you want to start it.

1 Press **MENU**

2 Use **ENTER** to select „ENERGY SAVER“ and then press **[ENTER]**.

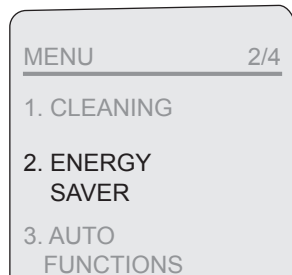

ENTER

AUTO ENERGY SAVER

TIMER ENERGY SAVER

TURNING OFF ENERGY SAVER

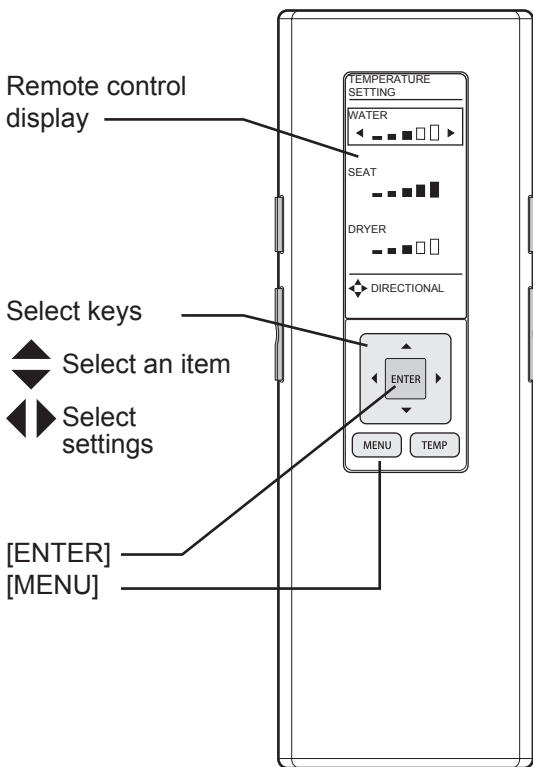

When energy saver is set, the ENERGY SAVER LED (green) lights up.

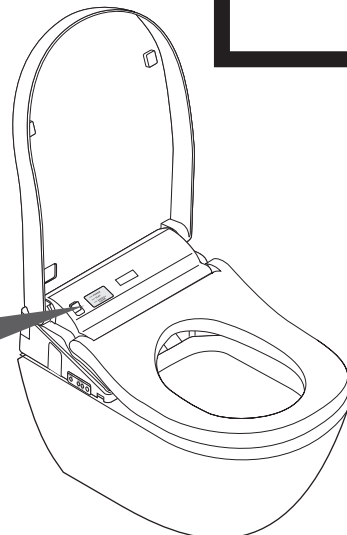
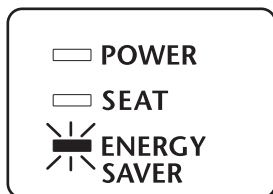

3 Use  to select „AUTO ENERGY SAVER“.

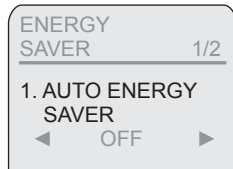

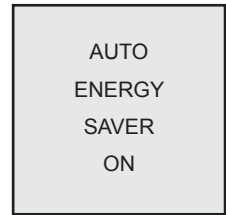
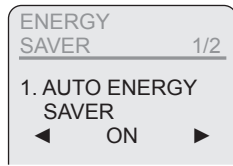
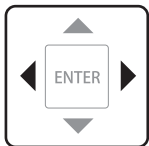

4 Select "ON/OFF" with  and then press [ENTER].

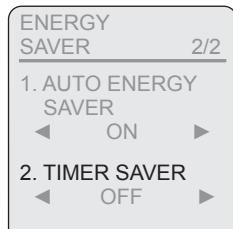
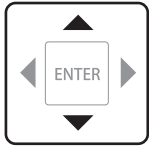

Press  to go back.

3 Use  to select "TIMER SAVER".



4 Select  "3H", "6H", "9H" or "OFF" and then Press [ENTER].

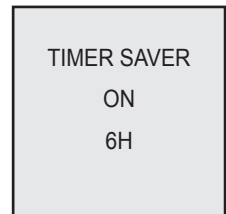
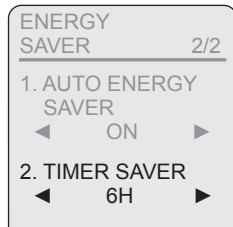
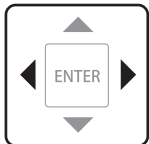

Press  to go back.

Set the start time for the energy saver timer to change the time for the energy saver timer.

Select "OFF" in step **4** of the procedures described above and then press [ENTER].

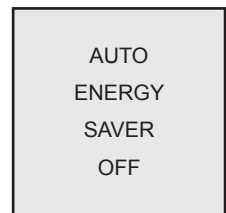
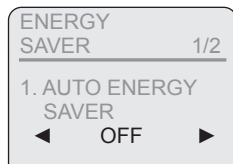

Press  to go back.

Maintenance

Plug



WARNING

Before cleaning, servicing or inspecting the product always flip the breaker on the distribution board to "OFF".

Main unit (perform daily)



Soft cloth soaked in water



- Toilet paper
- Dry cloth
- Nylon scrubbing pads (May cause damage)

For normal dirt

- Wipe with a soft cloth that has been soaked in water and wrung-out thoroughly.

For heavy dirt

- Wipe with a soft cloth soaked in diluted, neutral kitchen detergent, and then wipe with a soft cloth soaked in water. Wipe with moist towel.



pH neutral kitchen cleaning agent

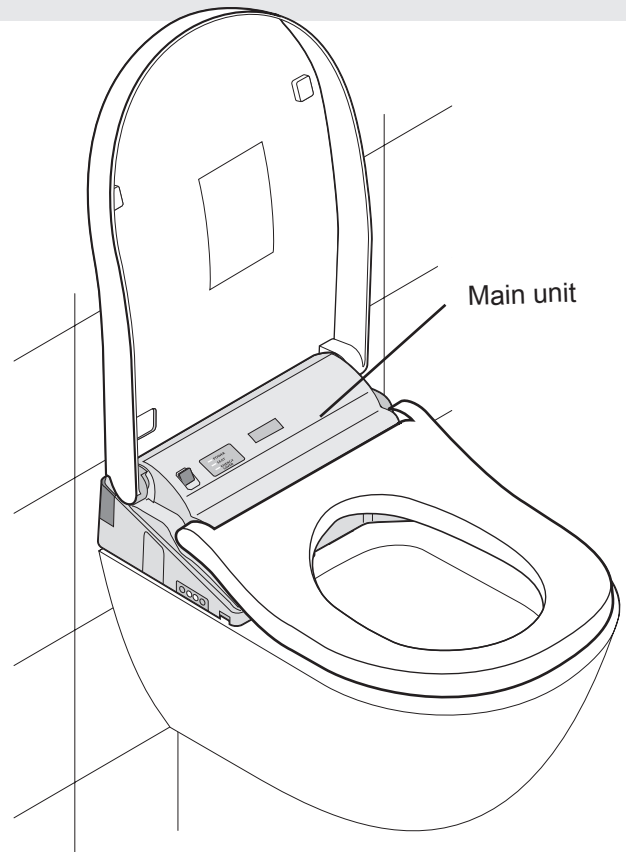

- Paint thinner
- Benzene
- Abrasive powdered cleaning agents

Attention!

VICLEAN[®] is an electronic device. Be careful not to let water seep inside or leave detergent in the gap between the main unit and toilet bowl.

- Doing so may damage plastic parts or cause a malfunction:
When using a toilet cleaner to clean the toilet, wash it off within 3 minutes and leave the toilet seat and lid open. Wipe off residual cleaning agent in the WC bowl.
- If vapour from a toilet bowl cleaner enters the main unit, it may cause a malfunction. Do not push or pull the nozzle cover or the warm air dryer cover with undue force.
- Doing so may cause damage or malfunction.

Gap between the main unit and the toilet lid (perform monthly)

The toilet lid can be removed for thorough cleaning.

1 Put the switch on the distribution board to "OFF".

- A** Pull the left side outward.
- B** Disconnect the hinge from the pin and pull up.
- C** Disconnect the right side.

Wipe with a soft cloth that has been soaked in water and wrung-out thoroughly.

2 Reinstall the toilet lid.

- D** Join the pin and the hinge on the right side.
- A** While pulling out the left side,
- E** mount by joining the hinge with the pin. (Be careful not to pinch your fingers.)

3 Put the switch on the distribution board to "ON".

Open and close the toilet lid to check proper re-installation.

To remove
and replace hold tight
with both hands.

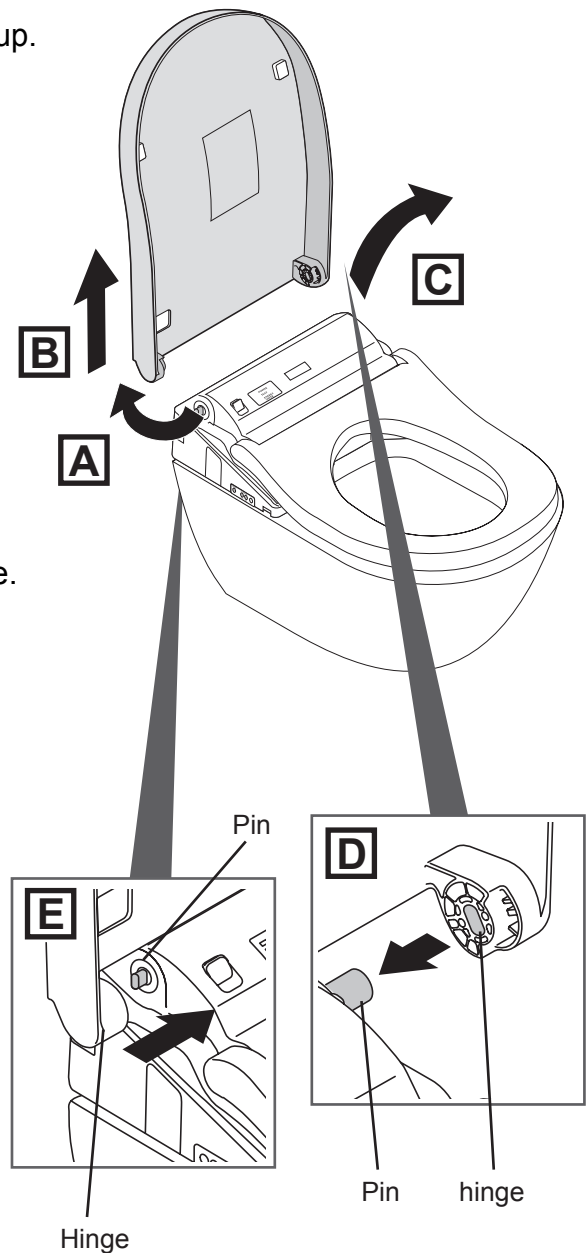

Maintenance

Air purifier filter (perform monthly)

If you notice odours:

1 Put the switch on the distribution board to "OFF".

2 Remove the air purifier filter.

- Hold the knob and pull outward.
- Do not pull with undue force. Doing so may cause damage or malfunctions.

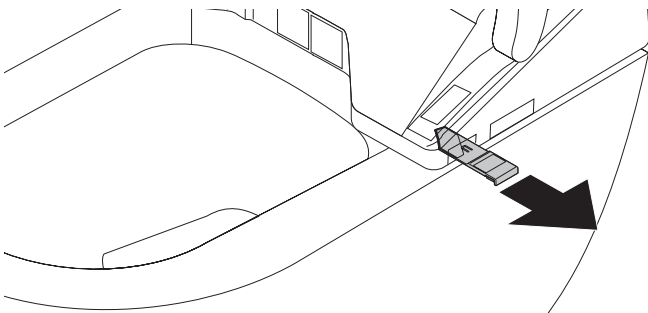

3 Clean with a tool such as a toothbrush.

- When washing with water, dry off all water before mounting.

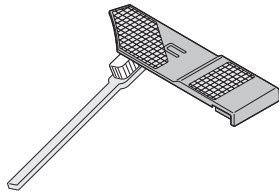

4 Mount the air purifier filter.

- Push firmly until a click sound is heard.

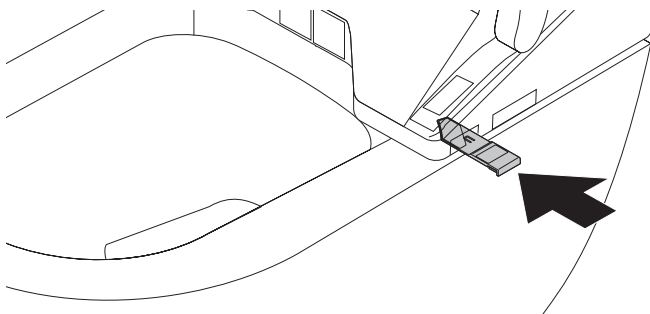

5 Put the switch on the distribution board to "ON".



Air purifier filter (perform monthly)

If you notice filth:

- 1** Extend the nozzle.
 - Operate with the buttons on the back side of the remote control.

- a. Press [MENU].
- b. Use  to select "CLEANING".

Press [ENTER].

- c. Use  to select "WAND CLEANING MODE ON/OFF".

Press [ENTER].

- The nozzle extends and water sprays out.
- The nozzle automatically retracts after about 5 minutes.

- 2** Wipe with a soft, wet cloth.
 - Do not pull, push or press the nozzle with excessive force. (Doing so may cause damage or malfunction.)

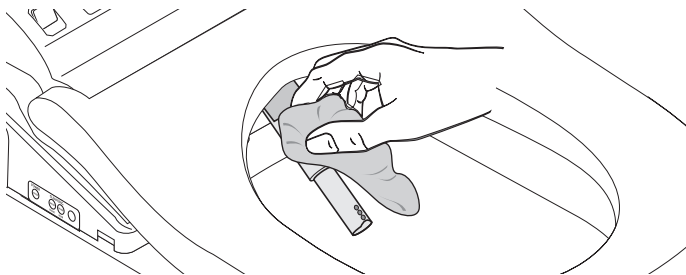

- 3** Press [STOP] on the front side of the remote control.
 - The nozzle retracts.

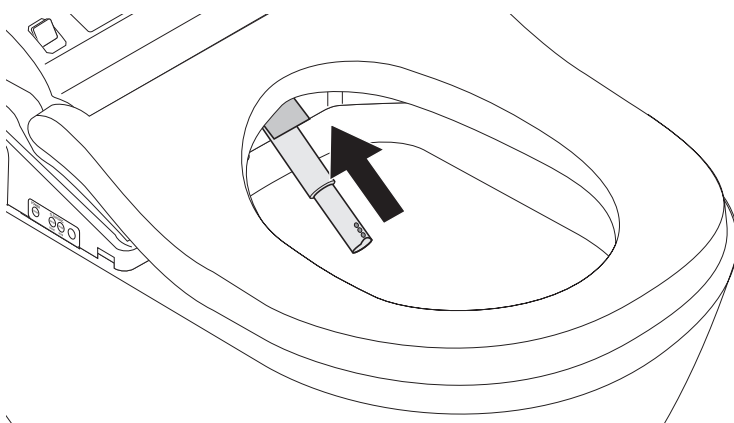

Soft cloth soaked in water



- Toilet paper
- Dry cloth
- Nylon scrubbing pads (May cause damage.)

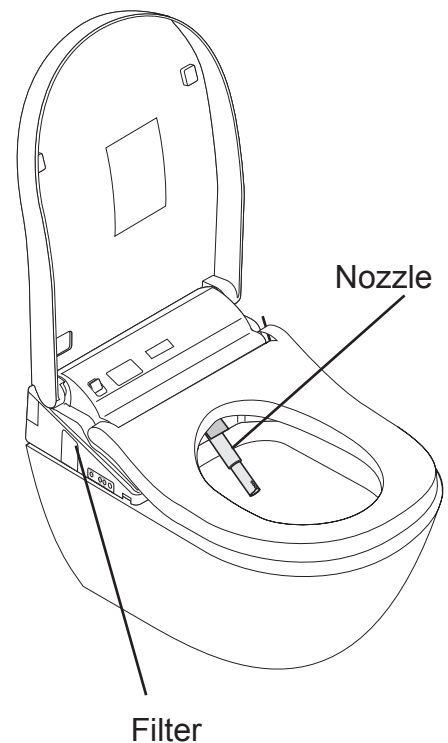

Maintenance

Cleaning the filter (perform once every 6 months)

If you think the water pressure has weakened:

- 1** Close the shut-off valve.
 - The water supply stops.

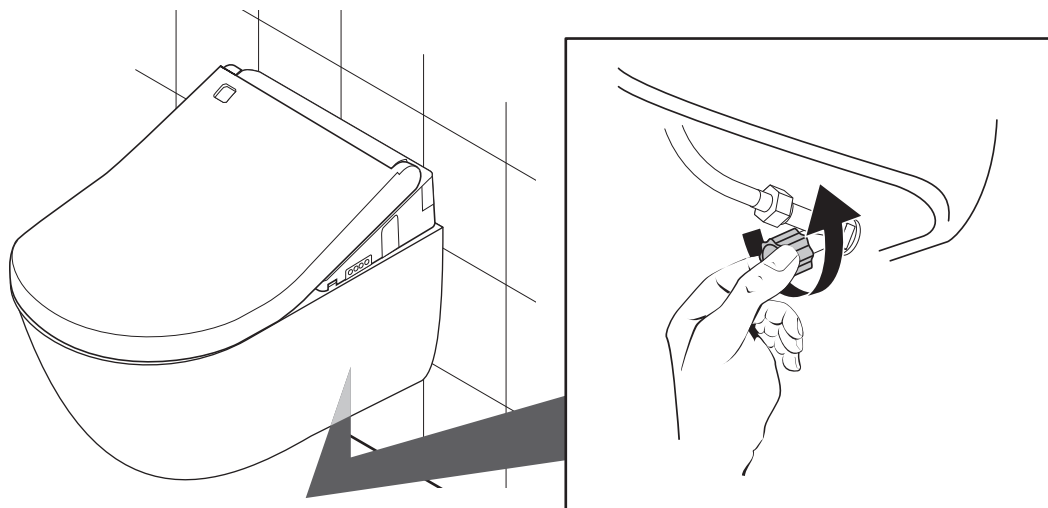

CAUTION



Do not remove the water filter while the shut-off valve is open.
(Otherwise, water may leak out.)

- 2** Extend the nozzle.
 - Operate with the buttons on the back side of the remote control.

- a. Press [MENU].
- b. Use  to select "CLEANING".

Press [ENTER].

- c. Use  to select "WAND CLEANING MODE ON/OFF".

Press [ENTER] to extend the nozzle.

Press [ENTER] again to retract the nozzle.
(Release the pressure from the water supply pipe.)

- 3** Put the switch on the distribution board to "OFF".

- 4** Remove cover and the filter.
- Loosen with a flat-head screwdriver and then pull.

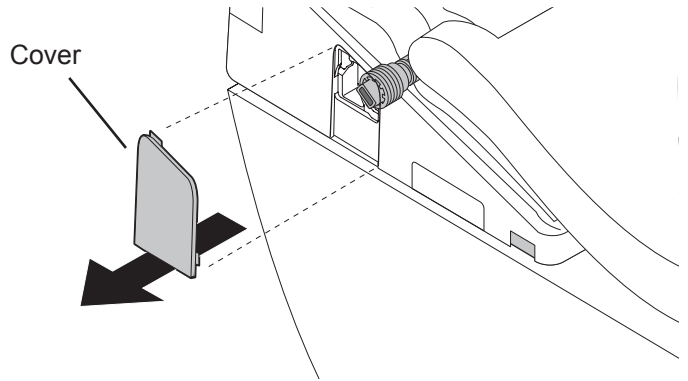

- 5** Clean with a tool such as a toothbrush.
- Also, remove any dust from inside the opening of the water filter.

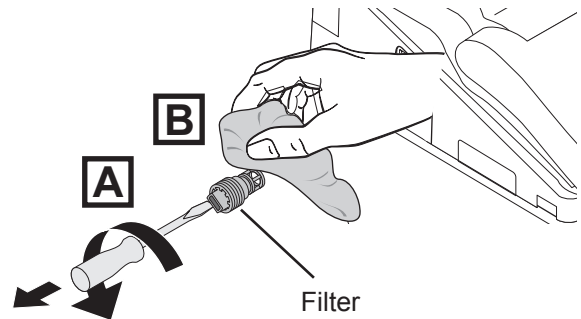

- 6** Replace the filter and the cover.
- Insert the filter and use a flat-head screwdriver to tighten it securely.

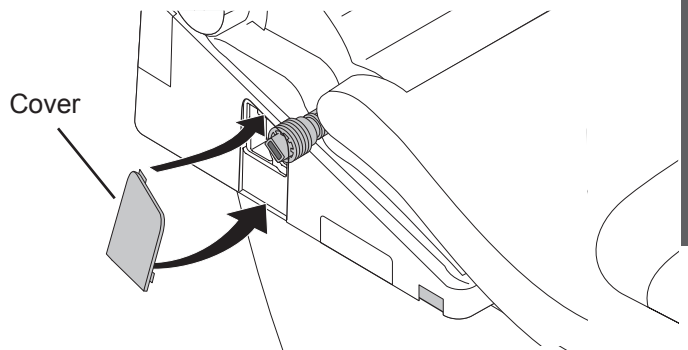

- 7** Put the switch on the distribution board to "ON".

- 8** Open the shut-off valve. (page 15)

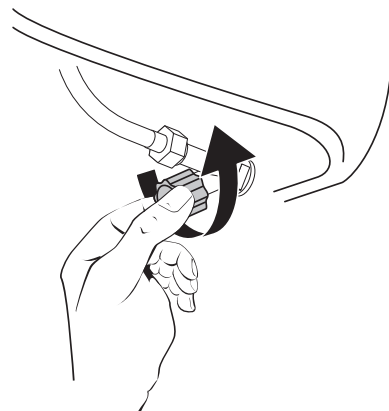

Change settings (Settings list)

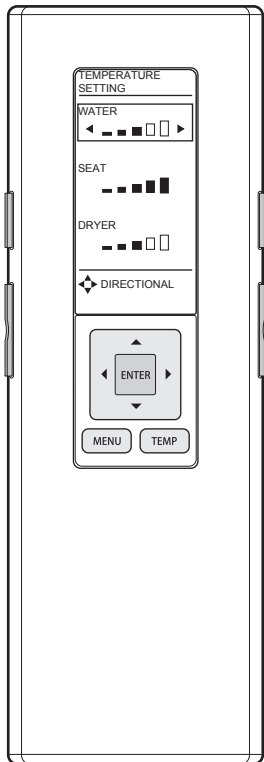

Setting Types		
AUTO FUNCTIONS Automatic functions	AUTO OPEN/ CLOSE	AUTO OPEN/ CLOSE
		AUTO CLOSE WAITING TIME
		AUTO OPEN WAITING TIME
		SEAT/LID
	CLEANING	AIR PURIFIER
OTHER SETTINGS Other settings	LIGHT	NIGHT LIGHT
	BEEP	
	SETTING LOCK	
		PERSONAL SETTING LOCK

Setting Types	Available Settings*	Page
<ul style="list-style-type: none"> • Set whether or not to open the toilet lid automatically 	ON/OFF	36
<ul style="list-style-type: none"> • Change the amount of time before the lid/seat closes automatically 	25SEC/90SEC	
<ul style="list-style-type: none"> • Change the amount of time after which the lid/seat opens automatically upon closing it manually 	15SEC/30SEC/90SEC	38
<ul style="list-style-type: none"> • Open and close toilet cover automatically/ Open and close toilet seat and toilet cover automatically 	LID/SEAT · LID	
<ul style="list-style-type: none"> • Set whether or not to deodorise automatically after sitting on the toilet seat 	ON/OFF	40
<ul style="list-style-type: none"> • Set whether or not to activate the night light 	ON/OFF	42
<ul style="list-style-type: none"> • Set whether or not to make a beep sound 	ON/OFF	44
<ul style="list-style-type: none"> • Set whether or not to use the setting lock 	ON/OFF	
<ul style="list-style-type: none"> • Set whether or not to use the personal setting lock 	ON/OFF	

*The black text is the initial setting.

Changing Settings (AUTO OPEN/CLOSE)

1 Press **MENU**

2 Use **▲** to select "AUTO FUNCTIONS" and then press **[ENTER]**

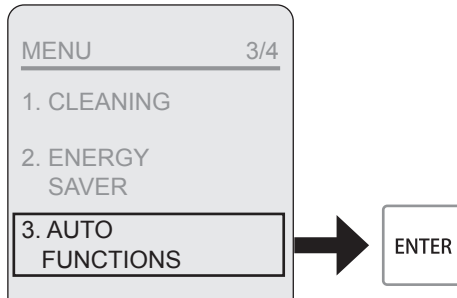

3 Use **▲** to select "AUTO OPEN/CLOSE" and then press **[ENTER]**

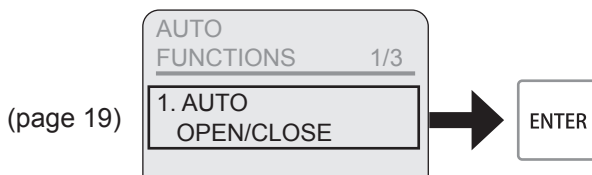

Set whether or not to open the toilet lid automatically

AUTO OPEN/CLOSE

Change the time before the lid/seat closes automatically (25 SEC or 90 SEC)^{*2}

AUTO CLOSE WAITING TIME^{*1}

Remote control display

Select keys

- ▲ Select an item
- ▼ Select settings

[ENTER]
[MENU]

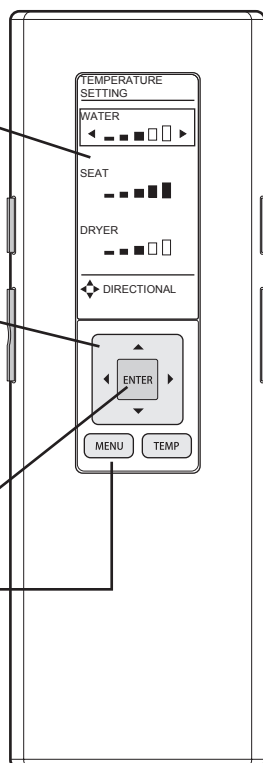

- Items set on this display:
- AUTO OPEN/CLOSE
 - AUTO CLOSE WAITING TIME

*1 This operation is not available when the "AUTO OPEN/CLOSE" is "OFF".

*2 When set to 25 seconds, the lid/seat does not open automatically for about 15 seconds after closing automatically.

4

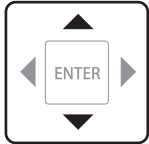

Use to select "AUTO OPEN/CLOSE".

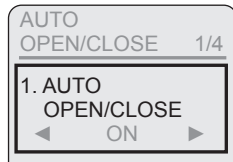

5

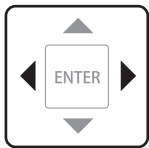

Select "ON/OFF" with and then press [ENTER].

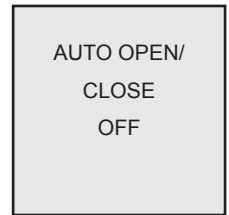
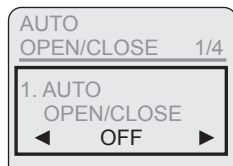

Press to go back.

4

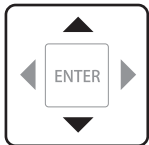

Use to select "AUTO CLOSE WAITING TIME".

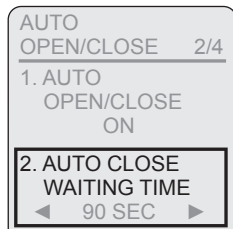

5

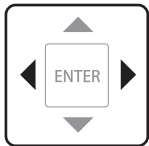

Use to select "25 SEC" or "90 SEC" and then press [ENTER].

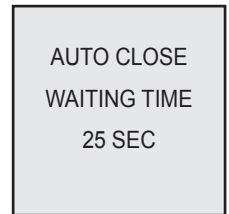
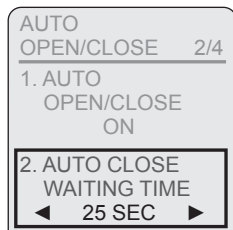

Press to go back.

Changing Settings (AUTO OPEN/CLOSE)

1 Press **MENU**

2 Use **ENTER** to select "AUTO FUNCTIONS" and then press **[ENTER]**

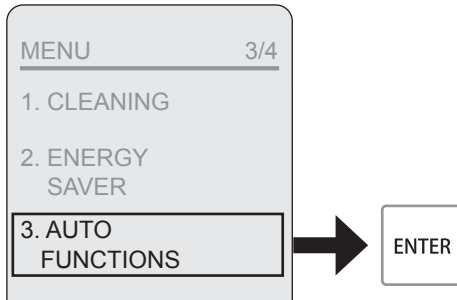

3 Use **ENTER** to select "AUTO OPEN/CLOSE" and then press **[ENTER]**

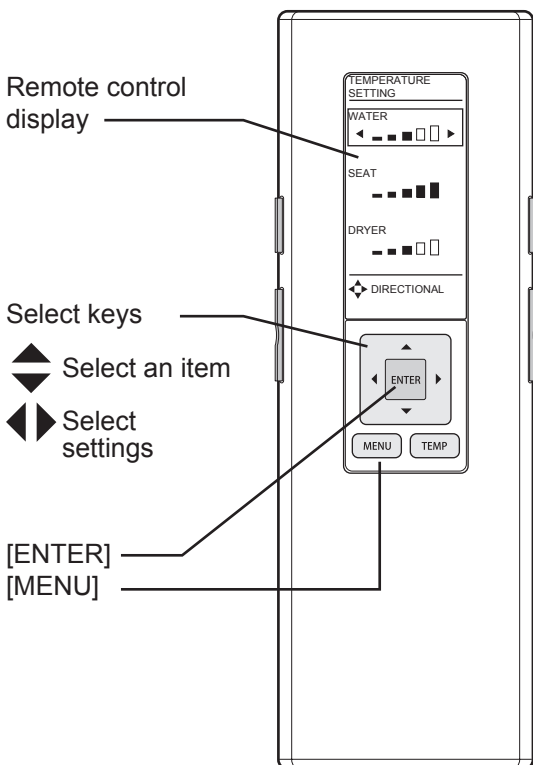
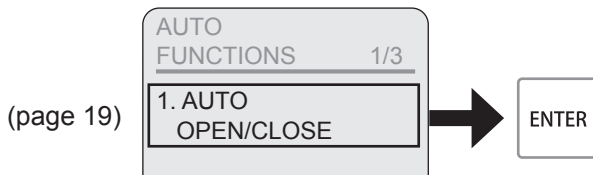

Items set on this display:

- AUTO OPEN WAITING TIME
- SEAT/LID*

Change the time period till automatic opening (15 SEC, 30 SEC or 90 SEC) (After closing manually)

AUTO OPEN WAITING TIME*

Automatically open and close the toilet lid only/
Automatically open and close the toilet seat and toilet lid

SEAT/LID*

* This operation is not available when the "AUTO OPEN/CLOSE" is "OFF".

4

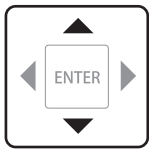

Use to select "AUTO OPEN WAITING TIME".

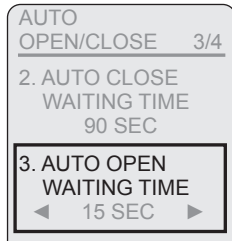

5



Use to select "15 SEC", "30 SEC" or "90 SEC" and then press [ENTER].

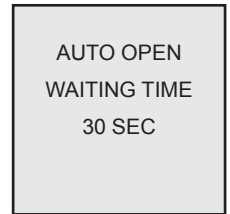
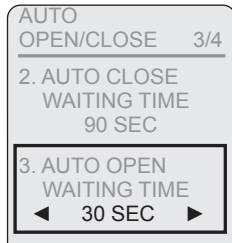

Press to go back.

4

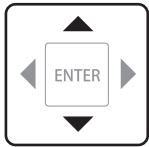

Use to select "SEAT/LID".



5

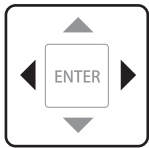

Select "LID" or "SEAT • LID" and then press [ENTER].

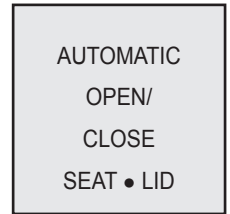
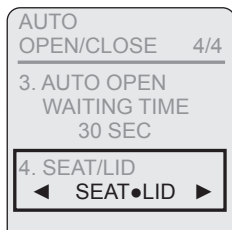

Press to go back.

Changing Settings (CLEANING)

1 Press **MENU**

2 Use **◀▶** to select "AUTO FUNCTIONS" and then press **[ENTER]**

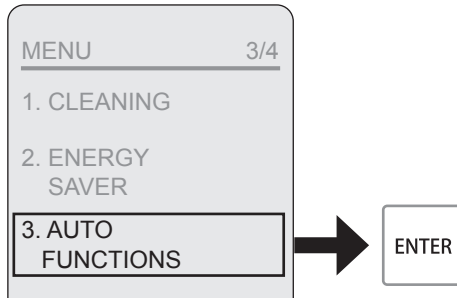

3 Use **◀▶** to select "CLEANING" and then press **[ENTER]**

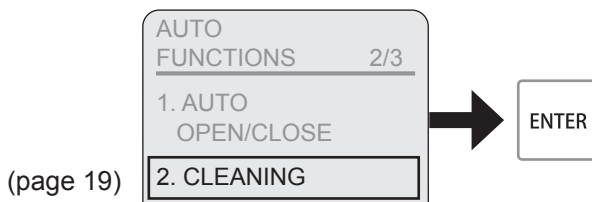

Set whether or not to deodorize automatically after sitting on the toilet seat

AIR PURIFIER

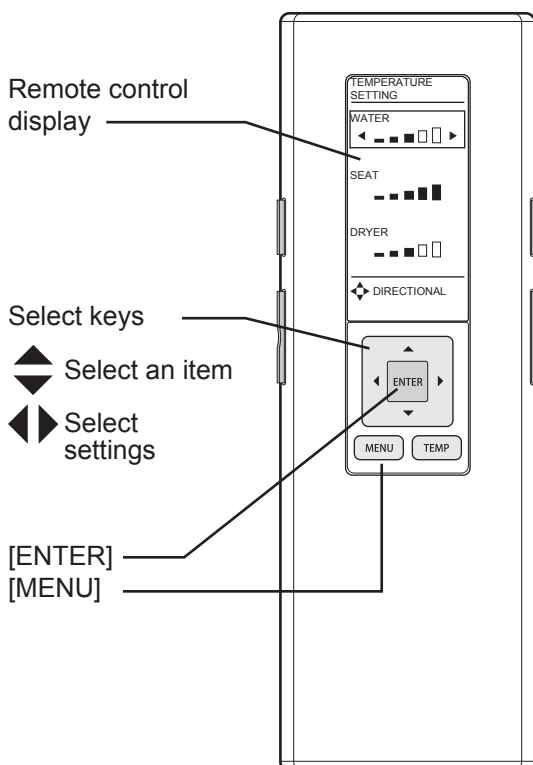

Items set on this display:

- AIR PURIFIER

4

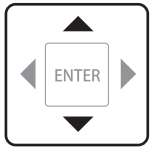

Use  to select "DEODORIZER".

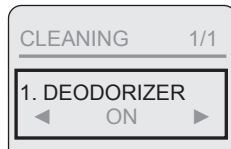

5



Select "ON/OFF" with  and then press [ENTER].

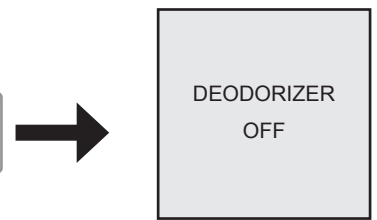
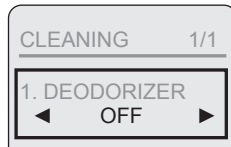

Press  to go back.

Changing Settings (LIGHT)

1 Press **MENU**

2 Use **ENTER** to select "AUTO FUNCTIONS" and then press [ENTER]

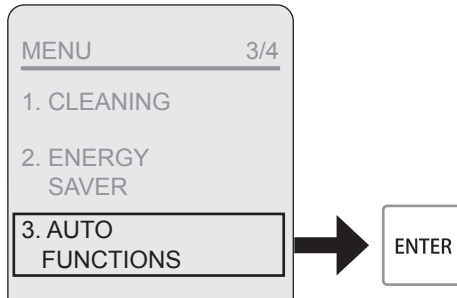

3 Use **ENTER** to select "LIGHT" and then press [ENTER]

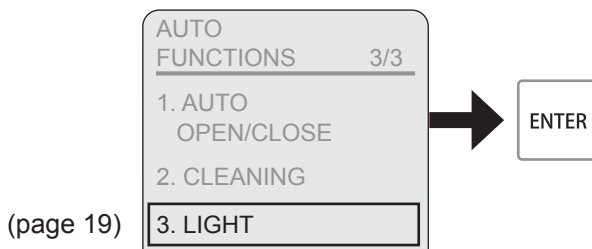

Set whether or not to use the night light

NIGHT LIGHT

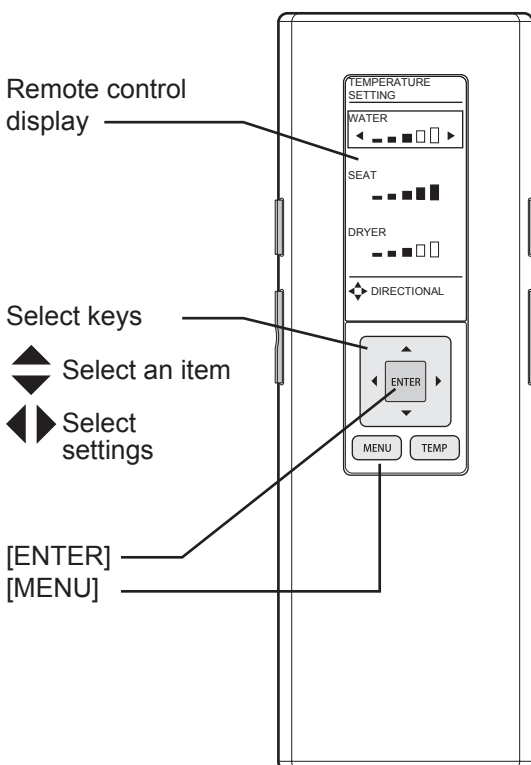

Items set on this display:
● SOFT LIGHT

4



Use  to select SOFT LIGHT.



5



Use  to select ON/OFF and then press [ENTER].

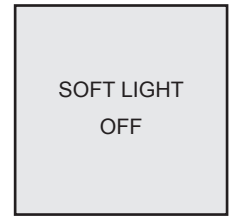

Press  to go back.

Changing Settings (OTHER SETTINGS)

1 Press **MENU**

2 Use **ENTER** to select "OTHER SETTINGS" and then press **[ENTER]**

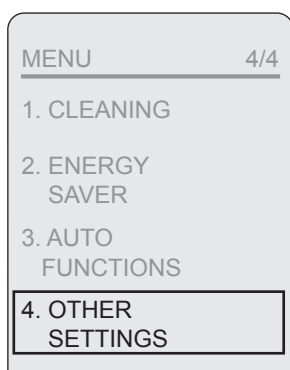

ENTER

Set whether or not to make a beep sound

BEEP

Set whether or not to use the setting lock

SETTING LOCK

Set whether or not to use the personal setting lock

PERSONAL SETTING LOCK

Remote control display

Select keys

- Select an item
- Select settings

[ENTER]
[MENU]

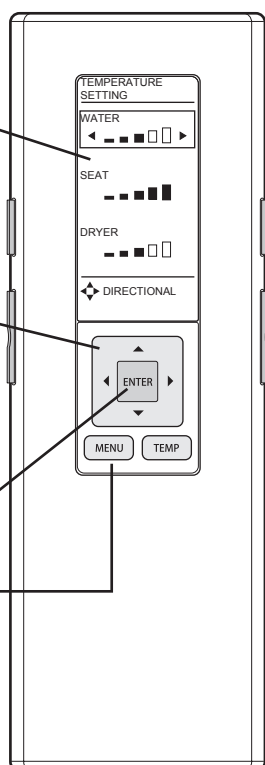

Items set on this display:

- BEEP
- SETTING LOCK
- PERSONAL SETTING LOCK

3

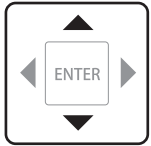

Use  to select "BEEP".

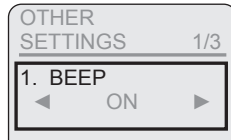

4

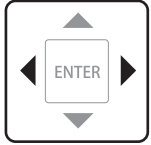

Use  to select "ON/OFF" and then press [ENTER].

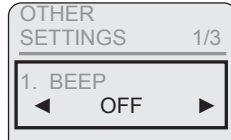

Press  to go back.

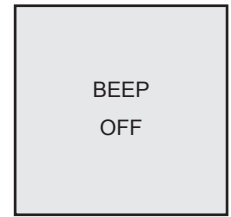

3

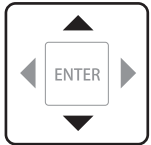

Use  to select "SETTING LOCK".

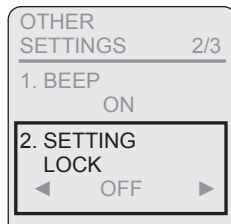

4

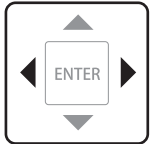

Use  to select "ON/OFF" and then press [ENTER].

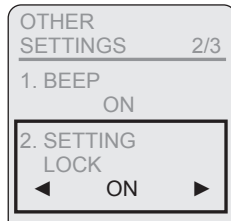

5

Check the displayed screen.

Display screen during setting lock

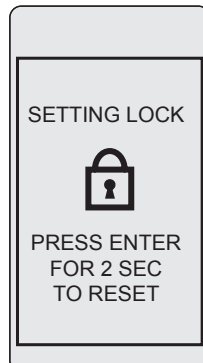

Cancellation method:
Press [ENTER] for 2 seconds.
If you want to relock after cancellation, reconfigure the setting.

3



Use  to select "PERSONAL SETTING LOCK".

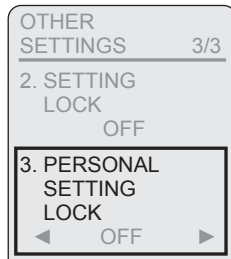

4



Use  to select "ON/OFF" and then press [ENTER].

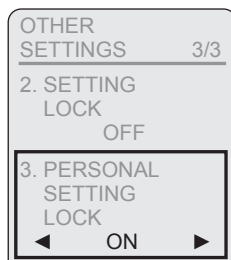

Press  to go back.

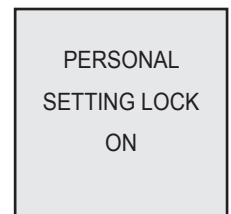

What to Do?

If you cannot operate with the remote control

- Operation is also possible using the buttons on the control panel.
- The batteries may have worn out. Replace the batteries.

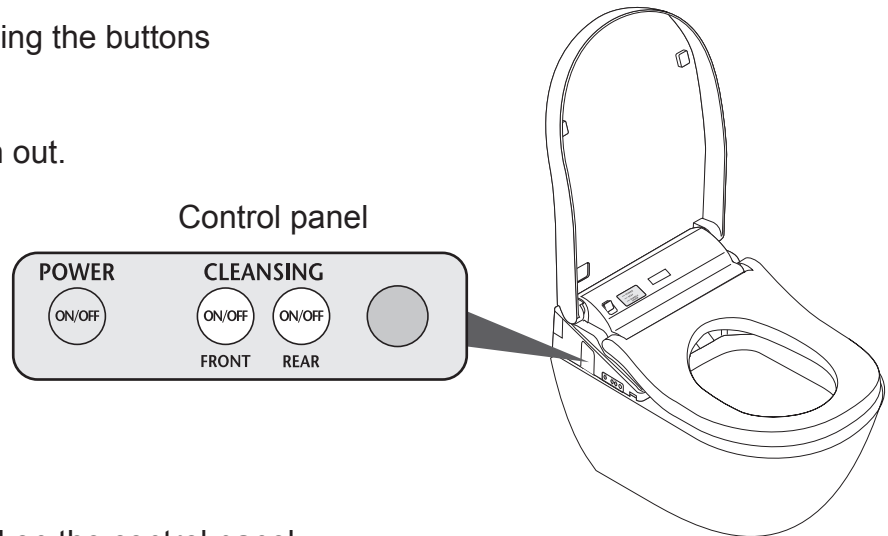

Replacing the batteries.

- 1** Press [POWER ON/OFF] on the control panel.
 - The POWER LED goes off.

- 2** Remove the remote control from the hanger. (page 14)

- 3** Open the cover and replace the AA batteries. (page 14)

- 4** Mount the remote control in the hanger.

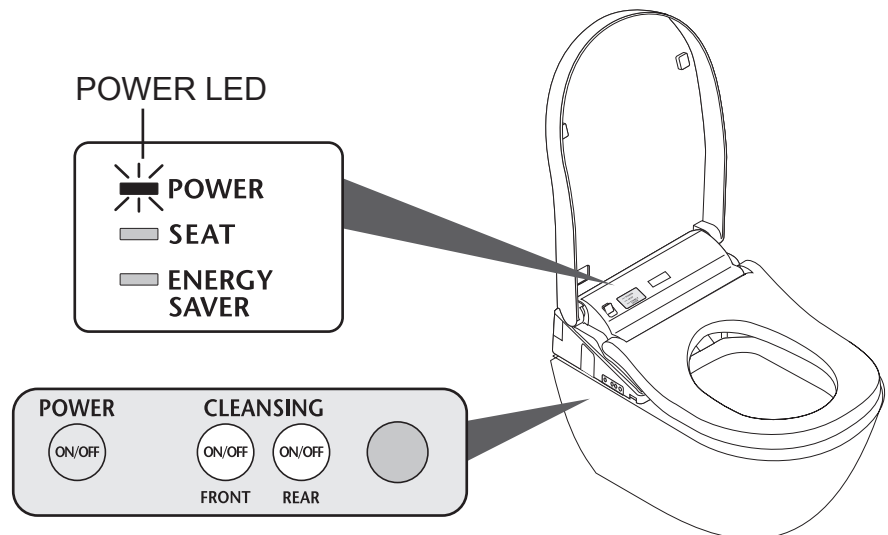

- 5** Press [POWER ON/OFF] on the control panel.
 - The POWER LED lights up.

What to Do? (Freeze Damage Prevention)

When the ambient temperature is likely to drop to 0°C or lower, take measures to prevent freezing.

Attention!

- When the ambient temperature is likely to drop to 0°C or lower, do not use the energy saver feature. (Doing so may damage the product.)
- Warm the bathroom or take measures against freeze so that the ambient temperature does not drop below 0°C.
- Prior to doing so, set "AUTO OPEN/CLOSE" (page 36) to "OFF".



Anti freezing

Draining the water

- 1** Close shut-off valve.



Drain the nozzle.

- 2** 1. Extend the nozzle.
 - Operate with the buttons on the back side of the remote control.
 - a. Press [MENU].
 - b. Use  to select "CLEANING".Press [ENTER].
 - c. Use  to select "WAND CLEANING MODE ON/OFF".Press [ENTER] to extend the nozzle.

Press [ENTER] again to retract the nozzle.
(Release the pressure from the water supply pipe.)

2. Set the breaker on the distribution board to "OFF".

3. Remove the cover and the filter.

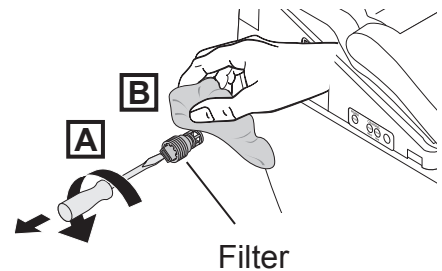
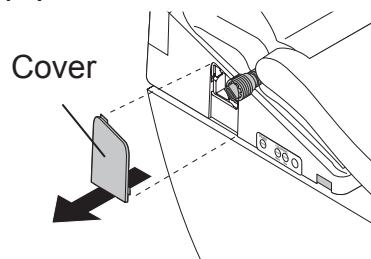

4. After draining the water, install the water filter and cover.
 - Insert the water filter and use a flat-head screwdriver to tighten it securely.

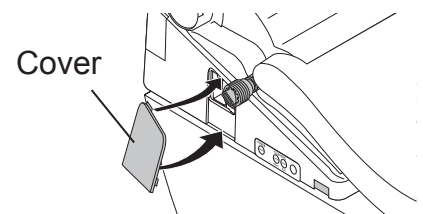

5. Put the switch on the distribution board to "ON".

- 3** Check that the POWER LED on the main display is lit up. (page 12)
- 4** Set the toilet seat temperature to "High". (page 22)
(To maintain the temperature.)
 - When finished, close the toilet seat and toilet lid.
- 5** Re-commissioning of VICLEAN™
 - The water needs to be resupplied. (page 48)

What to Do? (Longer Period of Disuse)

If the toilet is in a location you will not visit for a long time, drain the water.
(The water in the tank may become contaminated and cause skin irritation or other problems.)

Draining the water

1 Close the shut-off valve.
(Step **1** on page 47)

2 Drain the nozzle.
(Step **2** on page 47)

3 Pull out the water drain lever.
• The water comes out from near the nozzle for about 20 seconds.

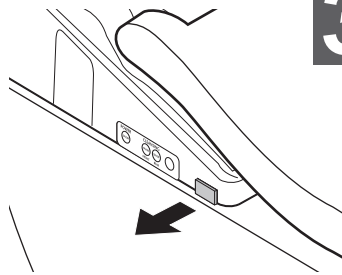

4 Release the water drain lever to return the water drain lever to its original position.

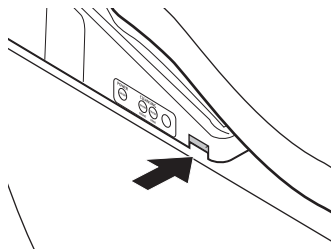

5 Take appropriate measures for the water remaining in the toilet bowl.
Putting antifreeze in the water remaining in the toilet bowl will reduce its chance of freezing.

- To use VICLEAN[®] again the water needs to be resupplied (see right).

Resupplying the Water (After draining)

1 Open the shut-off valve.
• Check that water is not leaking from a pipe or the main unit.

2 If the device is not turned on, set the switch on the distribution board to "ON".

3 Discharge water from the nozzle.
• Press down the left side of the toilet seat.
• Press the "REARWASH" on the remote control to discharge water from the nozzle.
(Catch the water in a paper cup or other receptacle.)

If the remaining water has frozen and no water comes out:

- Heat the inside of the bathroom, and warm the water supply hose and shut-off valve using a cloth soaked in warm water.

Troubleshooting

First, try the actions described on pages 49 to 54. If the problem persists, consult the installer, seller or the contact listed on the back cover of this manual.



CAUTION

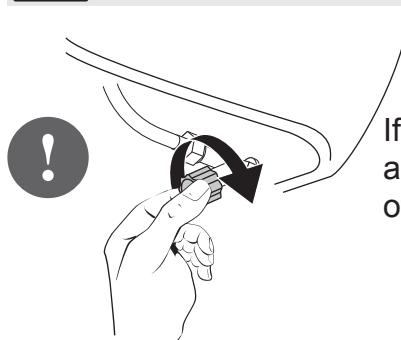

If a water leak occurs, always close the shut-off valve.

Please check first

Is the POWER LED lit?

- Does the LED light up when you press [POWER ON/OFF] on the main unit?
- Is the switch on the distribution board switched to "ON"?
Check whether there is a power outage or the breaker on the distribution board has turned OFF.

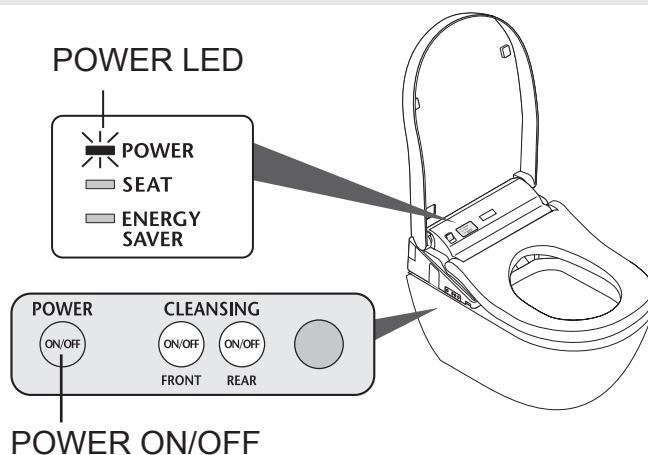

Is the ENERGY SAVER LED lit?

- While the LED is lit, the energy saver (page 24) is in operation, so the toilet seat temperature may be reduced or the heater may be turned off.

Is the remote control working?

Are the batteries in the remote control empty?

- Replace the batteries

Is the remote control transmitter or the remote control receiver blocked?

- Remove the blockages, filth, water drops and other impairments.

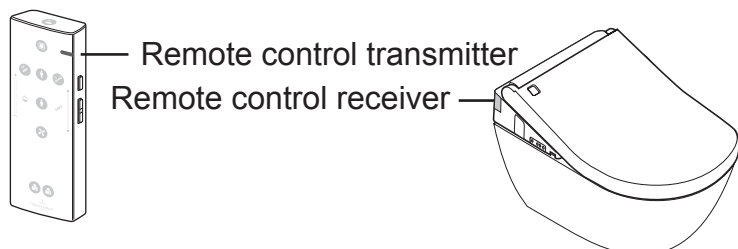

The remote control uses batteries to operate.

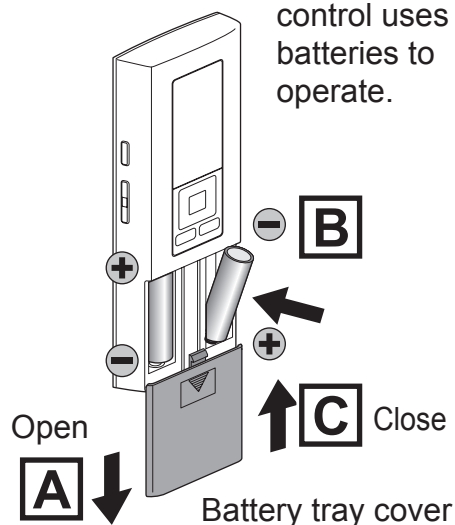

Troubleshooting

Rearwash and Ladywash, Nozzle

Trouble	Please check	Page
The nozzle (or cleanse water) does not come out	Can you operate with the control panel? (Check while sitting on the toilet seat.) <ul style="list-style-type: none"> See "Is the remote control working?" 	46 49
	When the temperature is too low, it takes time for the nozzle to come out after the remote control button is pressed because the water must be warmed up first.	-
	Did you sit on the toilet continuously for 2 hours or longer? (If so, operation is stopped for safety purposes.) <ul style="list-style-type: none"> Stand up from the seat and then use again. 	-
	If the water supply pressure drops significantly, for example if water is used elsewhere or if there is a water failure, the function may stop for safety reasons. <ul style="list-style-type: none"> Switch the breaker on the distribution board to "OFF" and wait about 10 seconds before inserting it again. If the same symptom reappears, there may be a malfunction. Consult with the contact listed on the back cover of this manual.	-
	The seat switch may have difficulty detecting some sitting postures. <ul style="list-style-type: none"> Sit back on the toilet seat. 	10
	Are you using a toilet seat cover, a toilet lid cover or a seat for infants? <ul style="list-style-type: none"> Remove all covers. If an infant seat with soft support is used, it needs to be removed after every usage. 	10
The nozzle extends but no cleanse water comes out / The cleanse water pressure is weak	Has a water failure occurred? <ul style="list-style-type: none"> Press the "STOP" button and wait until water service is restored. 	-
	Is the shut-off valve closed?	15
	Is the water filter clogged with foreign matter? <ul style="list-style-type: none"> Clean the filter. 	33
	Is the water pressure set to a low level?	-
The cleanse water is cold	Is the water temperature set to OFF or a low level? When the temperature of the water supply or the bathroom is low, the water temperature may be low when first sprayed.	22
The functions stops in the middle	Rearwash, soft cleanse and Ladywash stop automatically after 5 minutes of continuous use. After that, the POWER LED (green) and the ENERGY SAVER LED (green) on the display of the main unit flicker for about 60 sec. in order to prepare warm water. <ul style="list-style-type: none"> Wait until the LEDs on the display of the main unit light up steadily and then press the button again. 	-
	Does the seat switch have difficulty detecting? <ul style="list-style-type: none"> Sit back on the toilet seat. If you slightly lift up on the seat or sit on the front edge of the seat the seat switch may fail to detect your presence temporarily. 	10
Water comes out unexpectedly from the nozzle	Water comes out from the area around the nozzle for several seconds after you sat on the toilet seat and got up again.	-

Warm Air Drying

Trouble	Please check	Page
The warm air dryer temperature is too low	Is the remote control pre-set temperature set to a level that is too low?	22
Stops in the middle of use	<p>The feature stops automatically after 10 minutes of continuous use. Does the seat switch have difficulty detecting?</p> <ul style="list-style-type: none"> • Sit back on the toilet seat. If you get up slightly from the seat, or sit forward on the seat, the seating switch may temporarily stop detecting your presence. 	10

Toilet Seat and Toilet Lid

Trouble	Please check	Page
The toilet seat does not get warm	Is the toilet seat temperature set to "OFF" or a low level?	22
	<p>Is the ENERGY SAVER LED (green) lit?</p> <ul style="list-style-type: none"> • Energy saver timer is operating and has turned off the toilet seat heater. • When you sit on the seat, the heater is turned on temporarily and the seat is warmed for about 15 minutes. <p>Is the ENERGY SAVER LED (orange) lit?</p> <ul style="list-style-type: none"> • The toilet seat temperature has been lowered to save energy. (The auto energy saver in operation.) • When you sit on the seat, the heater is turned on temporarily and the seat is warmed for about 15 minutes. 	24
	<p>Have you been seated for a long time?</p> <ul style="list-style-type: none"> • After about 20 minutes of sitting, the temperature starts going down, and after about 1 hour, the heater is turned "OFF". • Move away from the toilet seat and then go back. 	-
	<p>The seat switch may have difficulty detecting some sitting postures.</p> <ul style="list-style-type: none"> • Sit back on the toilet seat. 	10
	<p>Is a toilet seat or lid cover installed?</p> <ul style="list-style-type: none"> • Remove any covers. 	10

Energy Saver

Trouble	Please check	Page
The energy saver timer feature is not working properly	<p>Did you replace the remote control batteries?</p> <ul style="list-style-type: none"> • When the batteries are discharged, the settings may be erased. • Reconfigure the setting. 	14 26
The auto energy-saver feature is not working properly	<p>Because the function takes several days learning the usage conditions before starting the energy saver, the amount of energy saving may be low despite infrequent usage.</p> <ul style="list-style-type: none"> • Check the which energy saver mode is active. 	24

Troubleshooting

Toilet Seat and Toilet Lid (AUTO OPEN/CLOSE)

Trouble	Please check	Page
<p>The toilet lid does not open automatically</p>	<p>Is "AUTO OPEN/CLOSE (LID)" set to "OFF"?</p> <ul style="list-style-type: none"> Set to "ON". <p>Does the body sensor have difficulty detecting?</p> <ul style="list-style-type: none"> Remove any dirt that is on the body sensor. <p>Even when set to "ON", AUTO OPEN/CLOSE (LID) is not performed for about 15 seconds after the toilet seat or toilet lid is closed.</p> <ul style="list-style-type: none"> When the toilet lid is closed by hand (To make VICLEAN™ user-friendlier, a time interval is set from when the lid is closed to when it will open next.) Leave the bathroom, and then after 15 seconds or more, approach the toilet bowl. Detection by the body sensor may be difficult when the room temperature exceeds 30°C. Then open and close manually. 	<p>36</p> <p>10</p> <p>20</p> <p>–</p>
	<p>Is "AUTO OPEN WAITING TIME" set to 30s or 90s?</p>	<p>38</p>
	<p>After inserting the plug the toilet cover does not open automatically for about 10 to 60 seconds.</p> <ul style="list-style-type: none"> Open and close by hand during this time. <p>After switching the breaker on the distribution board to ON, the toilet lid does not open automatically for about 10 to 60 seconds.</p> <ul style="list-style-type: none"> Open and close by hand during this time. 	<p>–</p>
	<p>Is a toilet seat or lid cover installed?</p> <ul style="list-style-type: none"> Remove any covers. 	<p>10</p>
<p>The toilet lid does not close automatically</p>	<p>Is "AUTO OPEN/CLOSE (LID)" set to "OFF"?</p> <ul style="list-style-type: none"> Set to "ON". <p>If you do not sit on the toilet seat or stand in front of it for less than 6 seconds, the toilet seat or toilet lid will then close after about 5 minutes.</p> <p>If they do not close automatically even though "AUTO OPEN/CLOSE (LID)" is set to "ON", the body sensor may be detecting incorrectly.</p> <ul style="list-style-type: none"> Should a reflective object be located in front of the toilet such as a mirror or glass move the reflecting object elsewhere or cover it with a curtain or something similar. 	<p>36</p> <p>20</p> <p>10</p>
	<p>Is the sensor directly exposed to sunlight?</p> <ul style="list-style-type: none"> Do not directly expose the sensor to sunlight, because it may cause incorrect detection. <p>Is there a heater within the detection range of the body sensor?</p> <ul style="list-style-type: none"> Do not place within the detection range of the body sensor. <p>Is a urinal or wash basin also installed in the bathroom?</p> <ul style="list-style-type: none"> The sensor may detect someone using the urinal, causing the toilet lid to open or close. 	<p>10</p>
<p>The toilet lid closes on its own</p>	<p>Is "AUTO OPEN/CLOSE (LID)" set to "ON"?</p> <p>Is "AUTO CLOSE WAITING TIME" set to 25 seconds?</p> <p>The seat switch may have difficulty detecting some sitting postures.</p> <ul style="list-style-type: none"> Sit back on the toilet seat. 	<p>36</p> <p>10</p>
	<p>Are the settings configured to open the toilet lid and toilet seat at the same time?</p>	<p>38</p>

Toilet Seat and Toilet Lid (AUTO OPEN/CLOSE)

Trouble	Please check	Page
Stops (or closes) while opening	<p>If the lid or seat hits an obstacle the first time it opens after inserting the power plug, it may stop (or close) partway during the next operation.</p> <ul style="list-style-type: none"> While there are no obstacles, disconnect the plug and insert it again after about 5 seconds. Then press the "OPEN/CLOSE (SEAT)" button on the remote control. <p>If the lid or seat hits an obstacle after the switch on the distribution board is first placed in the ON position, then it may stop half way through the next opening (or closing).</p> <ul style="list-style-type: none"> Place the switch on the distribution board to "OFF" and then remove the obstacle. Switch it to ON again after about 5 seconds. Then press the "OPEN/CLOSE (SEAT)" button on the remote control. 	–
Cannot open or close with the remote control	<p>If automatic opening is set:</p> <ul style="list-style-type: none"> See "Is the remote control working?" 	49
	<p>If automatic opening does not work either:</p> <ul style="list-style-type: none"> The toilet lid may not be mounted correctly. Mount it correctly. <p>Incorrect detection may occur when operating under fluorescent lights.</p>	29
		–

Air purifier

Trouble	Please check	Page
The air purifier seems to be not working	<p>Even after sitting down, you do not hear operation sounds:</p> <ul style="list-style-type: none"> Sit back on the toilet seat. 	10
	<p>If you hear an operation sound when you sit on the toilet seat.</p> <ul style="list-style-type: none"> Clean the air purifier filter. 	30
A strange odour is emitted	<p>Are you using an air freshener or air purifier that you purchased separately?</p> <ul style="list-style-type: none"> This may impair the effectiveness of the air purifier integrated in VICLEAN[®] and cause odours to develop. Remove the air freshener or air purifier. 	–
The air purifier is not working	<p>Is the "AIR PURIFIER" set to "OFF"?</p> <ul style="list-style-type: none"> Set to "ON". 	40

Night light

Trouble	Please check	Page
The night light does not light up	<p>Is the setting "OFF"?</p> <ul style="list-style-type: none"> Set to "ON". 	42

Troubleshooting

Others

Trouble	Please check	Page
Water is leaking from the plumbing connections	If any nuts in a connection are loose, firmly tighten them with a tool such as a monkey wrench. <ul style="list-style-type: none">• If the water leak does not stop, close the shut-off valve and seek repair.	–
The display on the remote control goes out	The display goes out when no button on the remote control is pressed for 5 minutes or more.	–
The main unit is unstable	There is clearance between the toilet seat cushion and the toilet bowl for activating the seat switch. When you sit on the toilet seat, it will lower discreetly to activate the seat switch.	10
The main unit makes a sound	When moving away from the toilet bowl after use <ul style="list-style-type: none">• You may hear the sound of the remaining water being drained.• You may hear the fan ventilating the unit.	20

Important User Guidance Information



If you want to dispose this product, do not mix it with general household waste. There is a separate collection system for used electronic products in accordance with legislation that requires proper treatment, recovery and recycling.

Private households in the member states of the EU, Switzerland and Norway may return their used electronic products free of charge to designated collection facilities or to a retailer (if you purchase a similar new one).

For countries not mentioned above, please contact your local authorities for the correct method of disposal.

By doing so you will ensure that your disposed product undergoes the necessary treatment, recovery and recycling, which prevent potential negative effects on the environment and human health.

Only discard discharged batteries. Batteries do not belong in the household waste, but rather at appropriate collection sites or at the product retailer.

Technical Data

Item

VICLEAN^{U+}

Rated voltage supply				AC 220 - 240V, 50Hz	
Rated power consumption				(variable) 845 - 855W	
Maximum power consumption				(variable) 1528 W (At a water supply temperature of 0°C)	
Mode				Instantaneous water heater	
Power cord length				0.62 m	
Water protection level				IPX4	
Functions	Cleanse	Spray volume	Rearwash	Approx. 0.27L to 0.43L/min.	
			Soft cleanse	Approx. 0.27L to 0.43L/min.	
			Ladywash	Approx. 0.29L to 0.43L/min.	
		Water temperature		Adjustable temperature range: OFF, about 30°C to 40°C	
		Heater capacity		1200 - 1428W	
		Safety device		Temperature fuse	
		Backflow prevention device		Vacuum breaker, air gap	
	Warm air dryer	Warm air temperature *		Adjustable temperature range : about 35°C to 55°C	
		Airflow volume		Approx. 0.29m ³ /min.	
		Heater capacity		200 - 238 W	
		Safety device		Thermal fuse	
	Heated seat	Surface temperature		Adjustable temperature range: OFF, about 28 °C to 36 °C (About 26°C when auto energy saver is in operation)	
		Heater capacity		55 - 65 W	
		Safety device		Temperature fuse	
	Air purifier	Method		O ₂ deodorizing	
		Airflow volume		Approx. 0.16 m ³ /min.	
		Power consumption		Approx. 5.3W	
	Water supply pressure				Minimum required water pressure: 0.1MPa (dynamic), Maximum required water pressure: 1.0 MPa (static)
	Water supply temperature				0°C to 35°C
Working ambient temperature				0°C to 40 °C	
Dimensions				W 392 mm x D 547 mm x H 134 mm	
Weight				(variable) about 5.6kg	

* Temperature around the warm air outlet measured by Villeroy & Boch.

Reference

VILLEROY & BOCH

GERMANY

*Villeroy & Boch AG
Unternehmensbereich Bad und Wellness
Hauptverwaltung
D-66693 Mettlach*

EN

07-2015

Colours and dimensions are subject to commonly accepted tolerances. Subject to technical changes and colour modifications.