

# HL310N-3123

< 0,50 l/sec  
DN 50/75/110

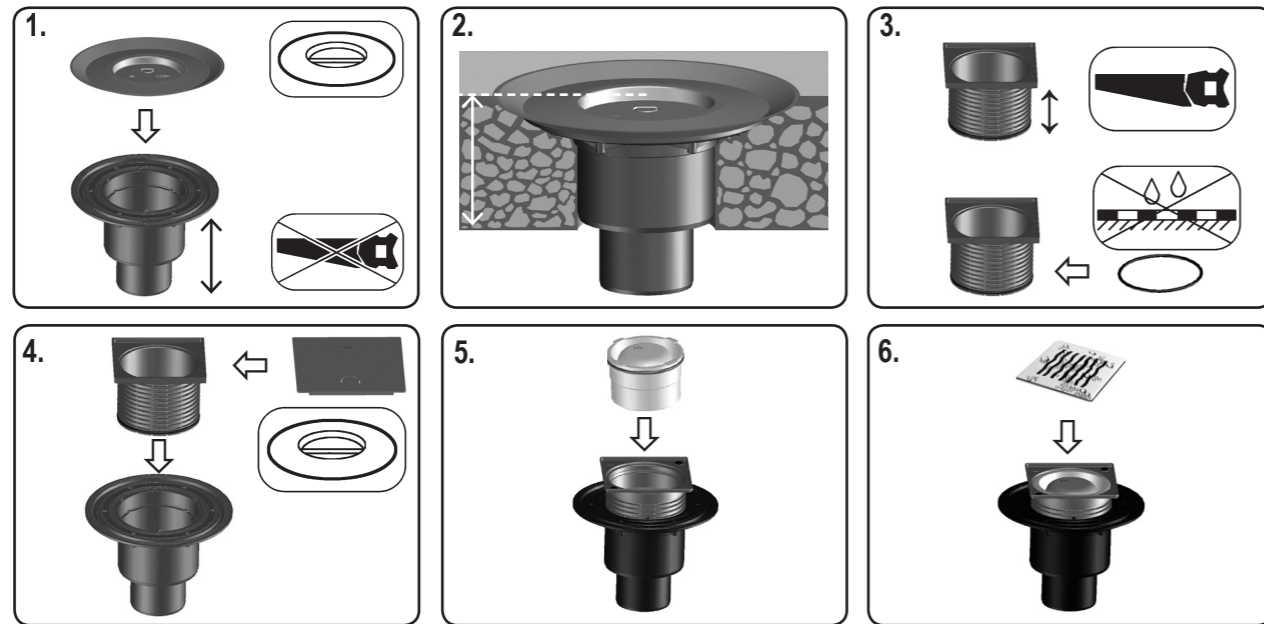

**D** BODENABLAUF  
**I** POZETTI  
**GB** FLOOR DRAIN

**TR** YER SÜZGEÇİ  
**CZ/SK** PODLAHOVÁ VPUST  
**HR** PODNI ODVOD

**H** PADLÓSZIFON  
**PL** WPUST PODLOGOWY  
**SLO** TALNI SIFON

**RO** SIFON DE PARDOSEALĂ  
**PYC** ТРАП  
**BUL** ПОДОВ СИФОН

# HL310N-3123

< 0,50 l/sec  
DN 50/75/110

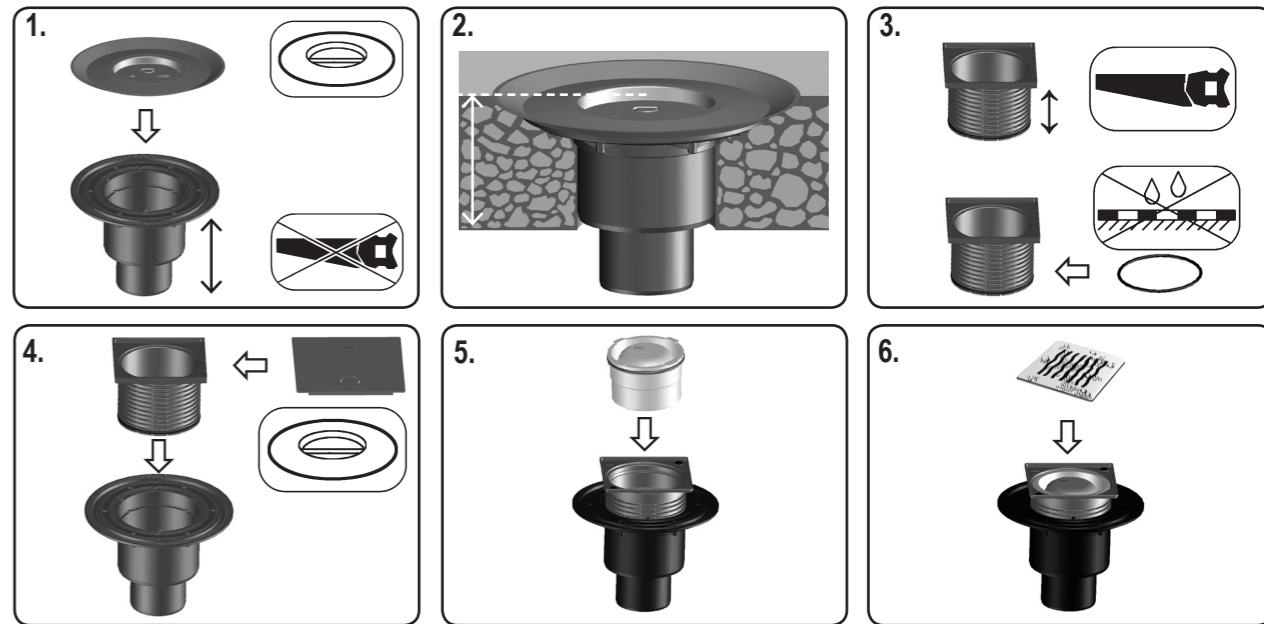

**D** BODENABLAUF  
**I** POZETTI  
**GB** FLOOR DRAIN

**TR** YER SÜZGEÇİ  
**CZ/SK** PODLAHOVÁ VPUST  
**HR** PODNI ODVOD

**H** PADLÓSZIFON  
**PL** WPUST PODLOGOWY  
**SLO** TALNI SIFON

**RO** SIFON DE PARDOSEALĂ  
**PYC** ТРАП  
**BUL** ПОДОВ СИФОН

# HL310N-3123

< 0,50 l/sec  
DN 50/75/110

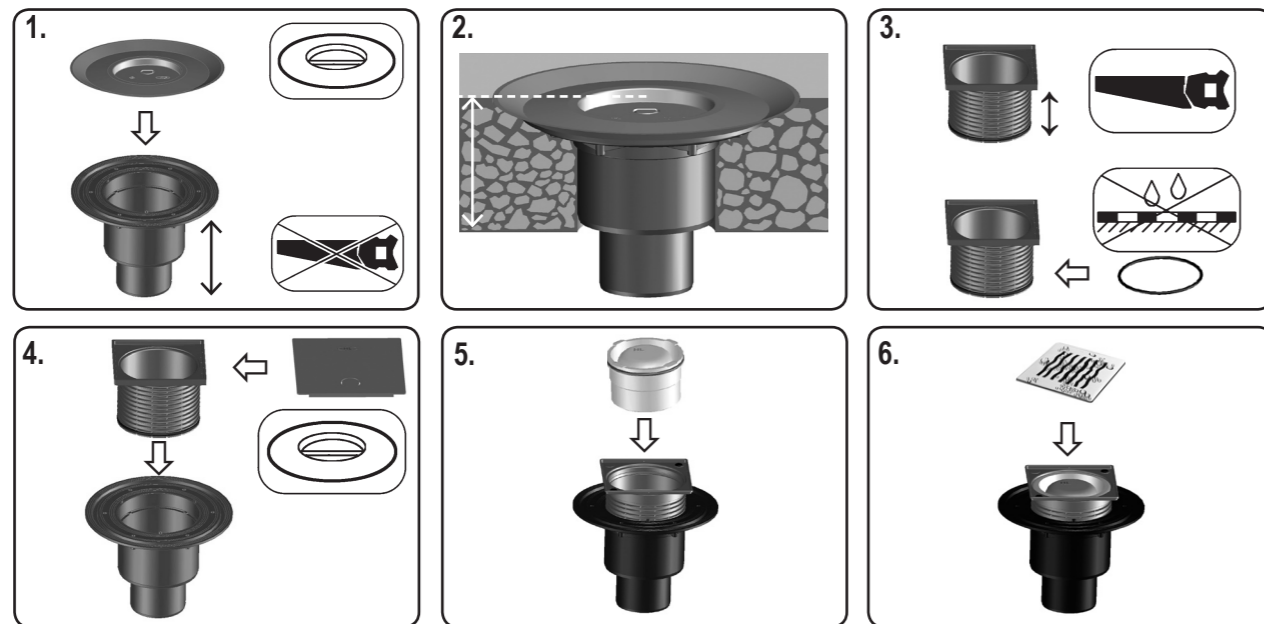
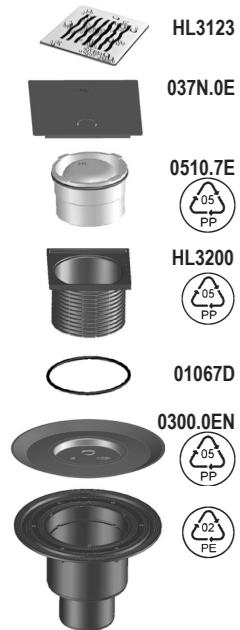

**D** BODENABLAUF  
**I** POZETTI  
**GB** FLOOR DRAIN

**TR** YER SÜZGEÇİ  
**CZ/SK** PODLAHOVÁ VPUST  
**HR** PODNI ODVOD

**H** PADLÓSZIFON  
**PL** WPUST PODLOGOWY  
**SLO** TALNI SIFON

**RO** SIFON DE PARDOSEALĂ  
**PYC** ТРАП  
**BUL** ПОДОВ СИФОН

# HL310N-3123

< 0,50 l/sec  
DN 50/75/110

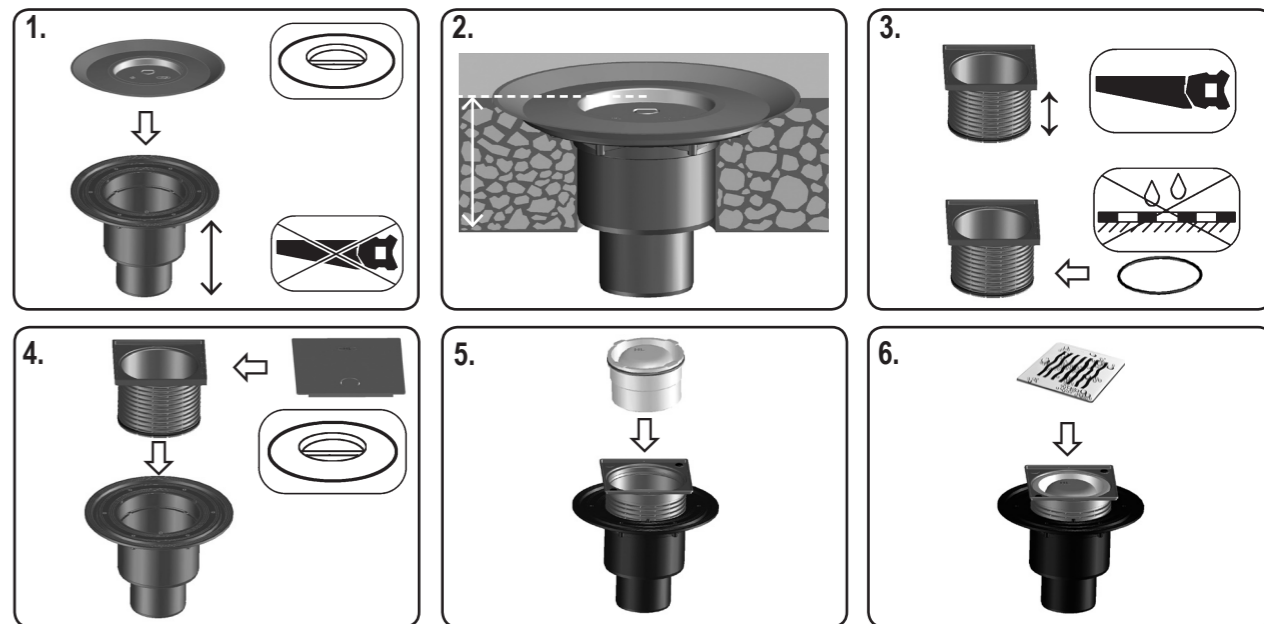

**D** BODENABLAUF  
**I** POZETTI  
**GB** FLOOR DRAIN

**TR** YER SÜZGEÇİ  
**CZ/SK** PODLAHOVÁ VPUST  
**HR** PODNI ODVOD

**H** PADLÓSZIFON  
**PL** WPUST PODLOGOWY  
**SLO** TALNI SIFON

**RO** SIFON DE PARDOSEALĂ  
**PYC** ТРАП  
**BUL** ПОДОВ СИФОН