

HL310N-3121

< 0,50 l/sec
DN 50/75/110

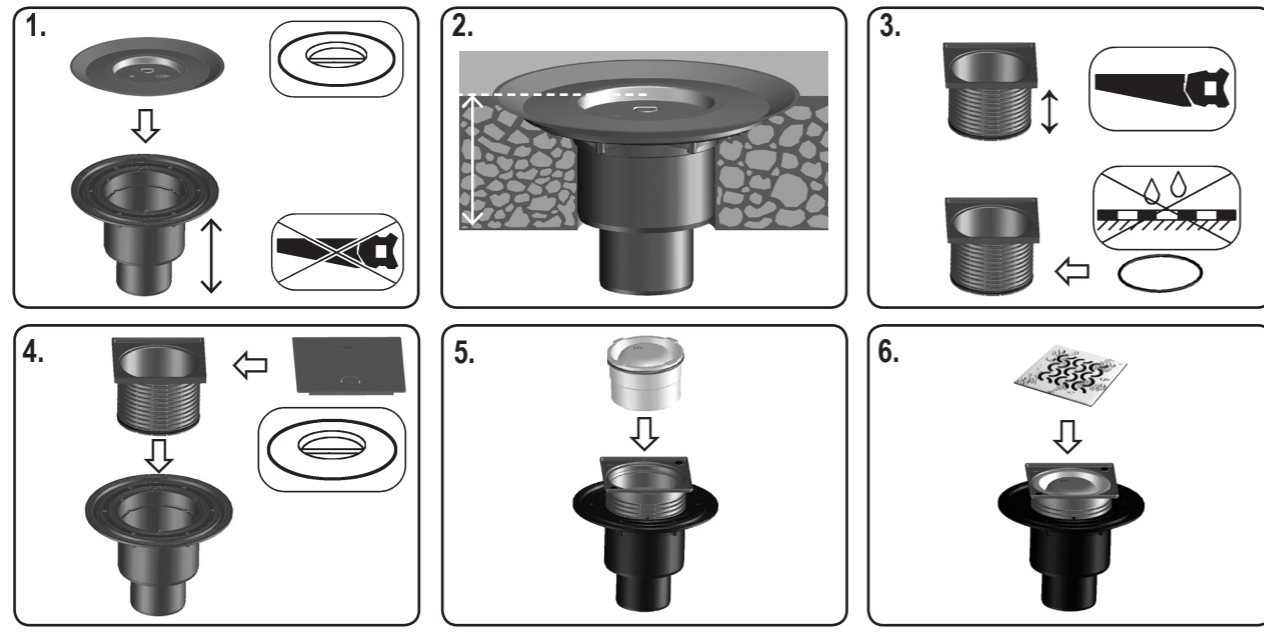

D BODENABLAUF
I POZETTI
GB FLOOR DRAIN
TR YER SÜZGEÇİ
CZ/SK PODLAHOVÁ VPUST
HR PODNI ODVOD
H PADLÓSZIFON
PL WPUST PODLOGOWY
SLO TALNI SIFON
RO SIFON DE PARDOSEALĂ
PYC ТРАП
BUL ПОДОВ СИФОН

HL310N-3121

< 0,50 l/sec
DN 50/75/110

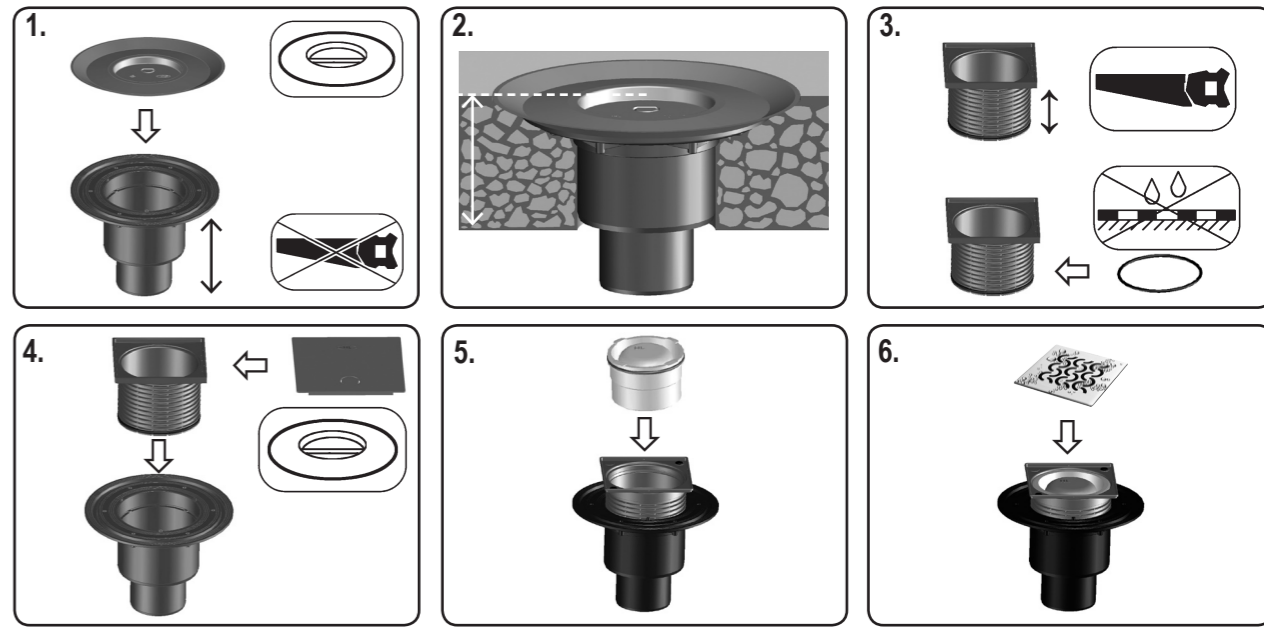

D BODENABLAUF
I POZETTI
GB FLOOR DRAIN
TR YER SÜZGEÇİ
CZ/SK PODLAHOVÁ VPUST
HR PODNI ODVOD
H PADLÓSZIFON
PL WPUST PODLOGOWY
SLO TALNI SIFON
RO SIFON DE PARDOSEALĂ
PYC ТРАП
BUL ПОДОВ СИФОН

HL310N-3121

< 0,50 l/sec
DN 50/75/110

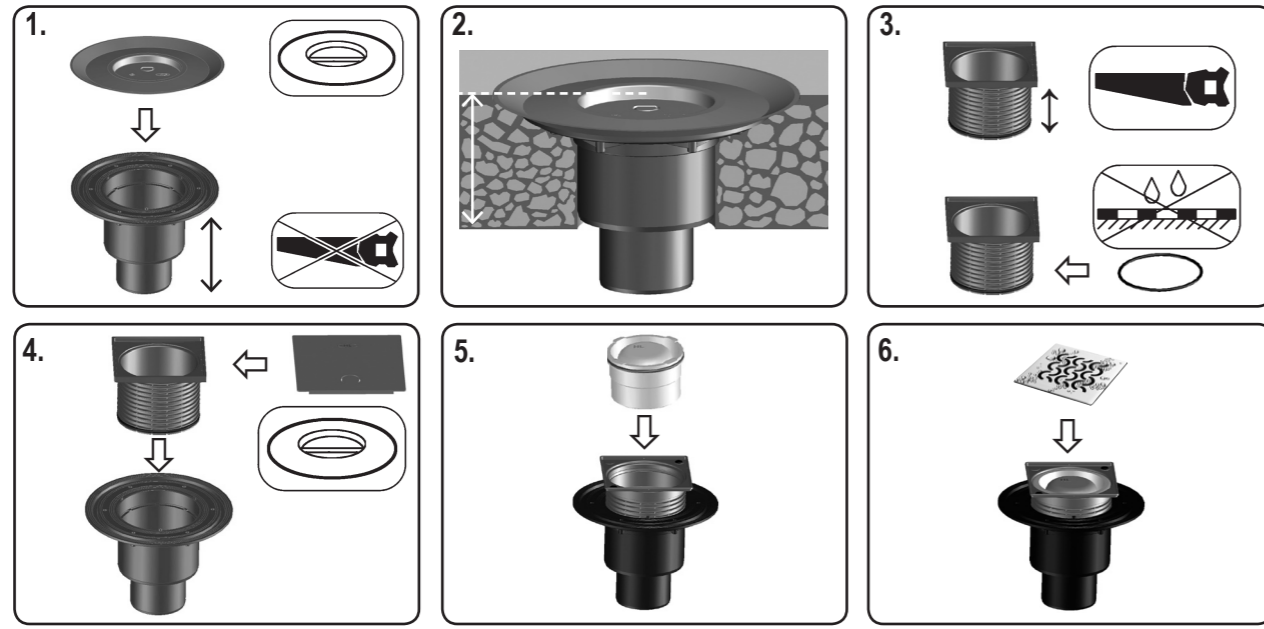

D BODENABLAUF
I POZETTI
GB FLOOR DRAIN
TR YER SÜZGEÇİ
CZ/SK PODLAHOVÁ VPUST
HR PODNI ODVOD
H PADLÓSZIFON
PL WPUST PODLOGOWY
SLO TALNI SIFON
RO SIFON DE PARDOSEALĂ
PYC ТРАП
BUL ПОДОВ СИФОН

HL310N-3121

< 0,50 l/sec
DN 50/75/110

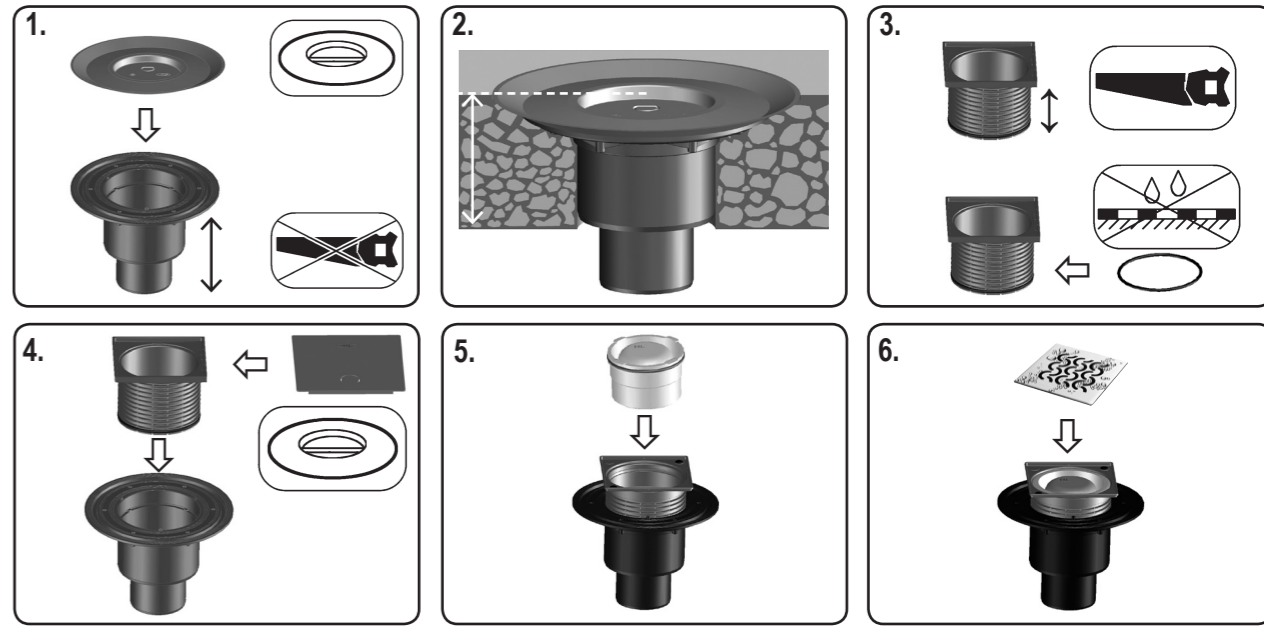

D BODENABLAUF
I POZETTI
GB FLOOR DRAIN
TR YER SÜZGEÇİ
CZ/SK PODLAHOVÁ VPUST
HR PODNI ODVOD
H PADLÓSZIFON
PL WPUST PODLOGOWY
SLO TALNI SIFON
RO SIFON DE PARDOSEALĂ
PYC ТРАП
BUL ПОДОВ СИФОН