

Ø 500

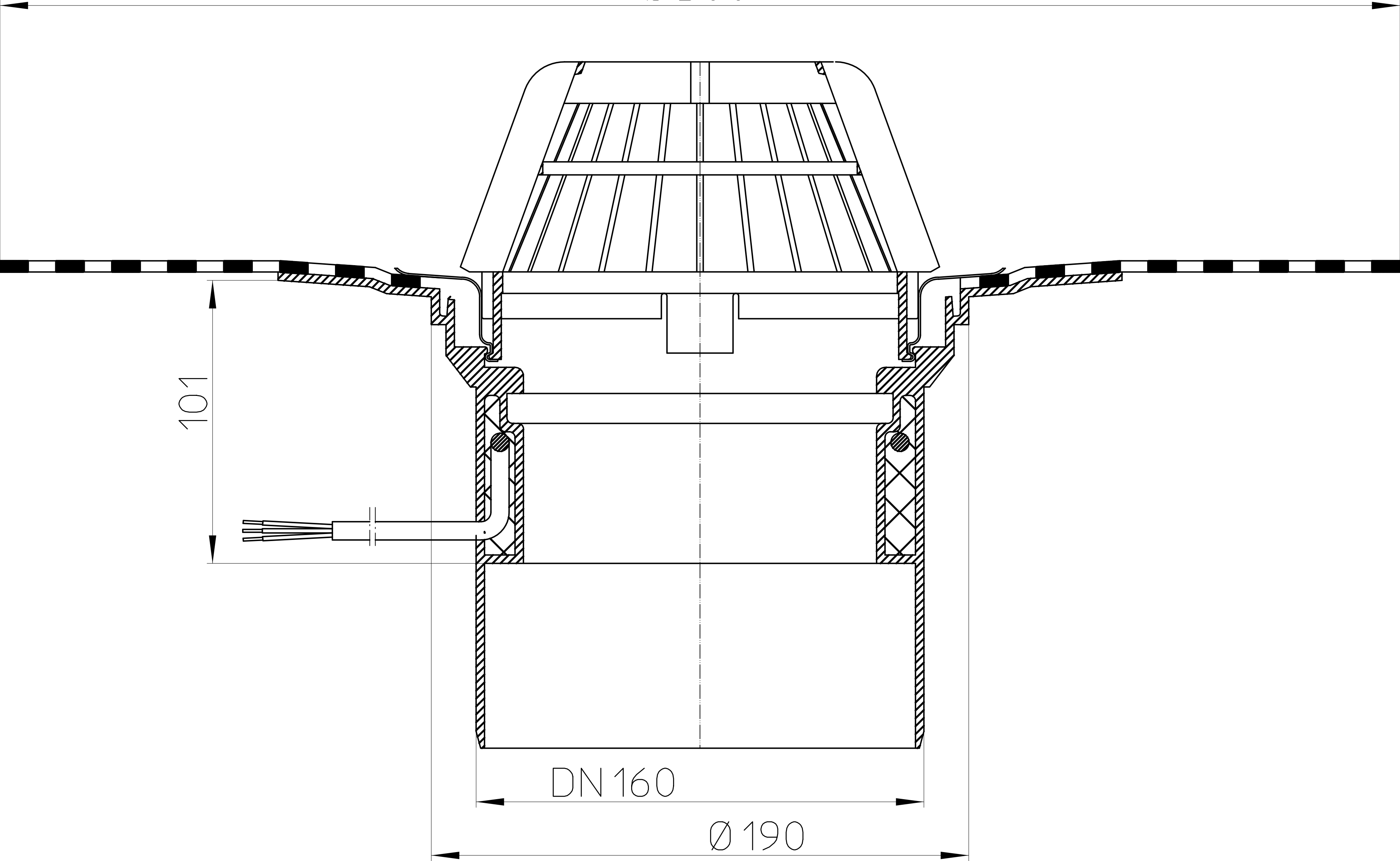

101

DN 160

Ø 190