

# INSTALLATION

## XETIS INSTALLATION SETS 1, 2 OR 3

### Waste fitting KA 200

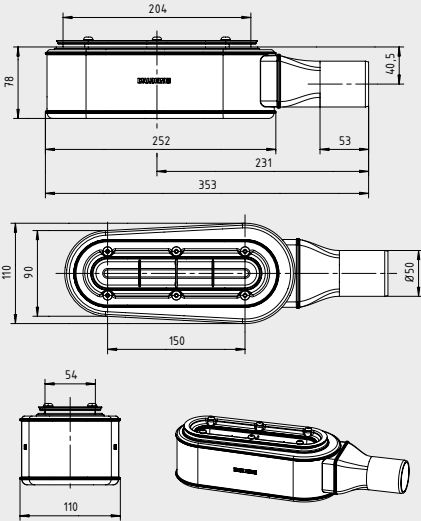

### Installation cover



### XETIS sealing system XDS

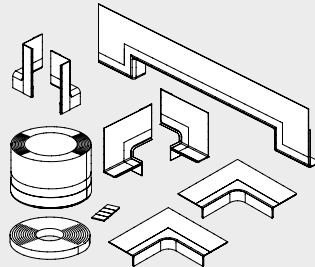

### Designer cover for tiling (included in installation set 1)

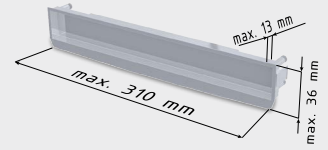

Order No.  
687676260000

or

### Designer cover polished chrome plate (included in installation set 2)



Order No.  
687676270000

or

### Designer cover, polished chrome, with collar\* (included in installation set 3)



Order No.  
687676370000

XETIS installation sets	Order No.	EUR
<b>XETIS installation set 1</b> <b>with designer cover for tiling</b> includes waste fitting KA 200, XETIS sealing system XDS, installation cover, designer cover for tiling	687676310000	
<b>or</b>		
<b>XETIS installation set 2</b> <b>with designer cover polished chrome plate</b> includes waste fitting KA 200, XETIS sealing system XDS, installation cover, designer cover polished chrome plate	687676320000	
<b>or</b>		
<b>XETIS installation set 3</b> <b>with designer cover, polished chrome, with collar</b> includes waste fitting KA 200, XETIS sealing system XDS, installation cover, designer cover polished chrome plate with collar	687676390000	

## XETIS INSTALLATION SOLUTION MAS 5305 CENTRAL SUPPORT SYSTEM

### Number and positioning:

#### 1 x MAS

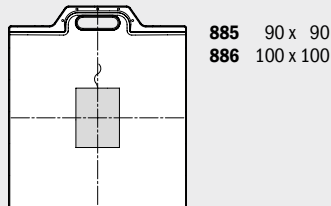

#### 2 x MAS

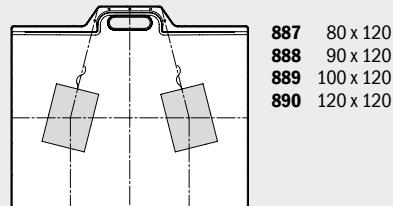

#### 3 x MAS

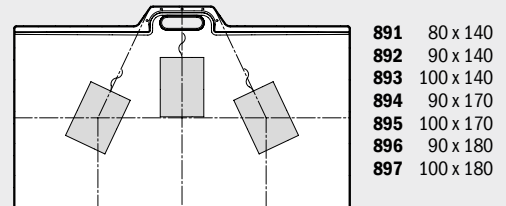

Central support system MAS 5305	Order No.	EUR
Recommended for shower trays with assembly or installation frame FR 5300 FLEX whose side length is 90 cm and longer. 240 x 300 mm (W x L), Height: 48 to 135 mm (adjustable).  Set comprising: 2 x double-sided adhesive tape 1 x upper wedge 1 x lower wedge 1 x pull plate (ready-mounted) 1 x pull cord (ready-mounted) 1 x adapter panel 40 mm 1 x adapter panel 20 cm	688076530000	

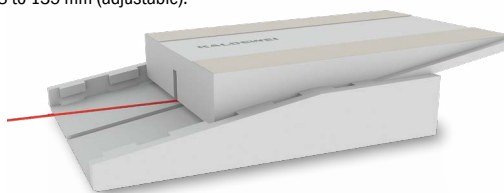

To meet the strict requirements of DIN 4109 - Sound insulation in buildings and VDI 4100/SST3, please use the XETIS sound insulation solution; see page 310.