

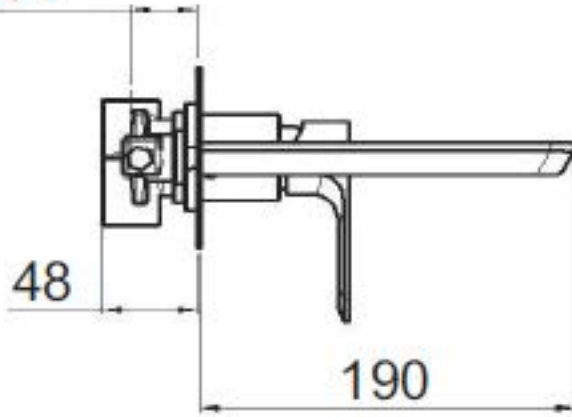

30/64



220

153

69

100

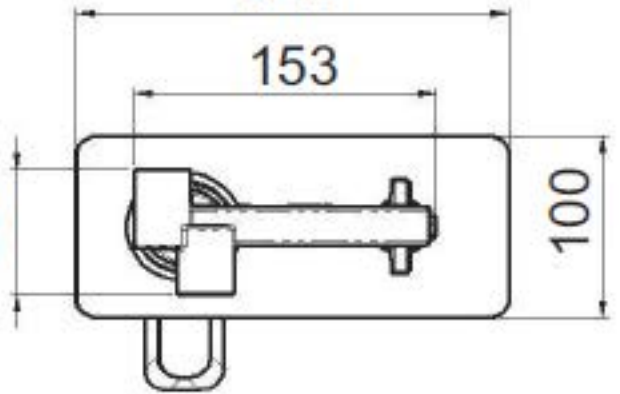

COLD
G1/2

HOT
G1/2

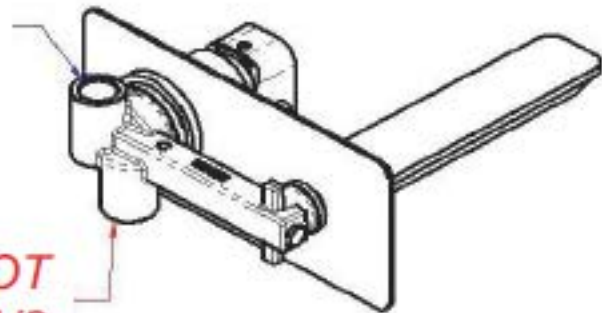

PY08/15